

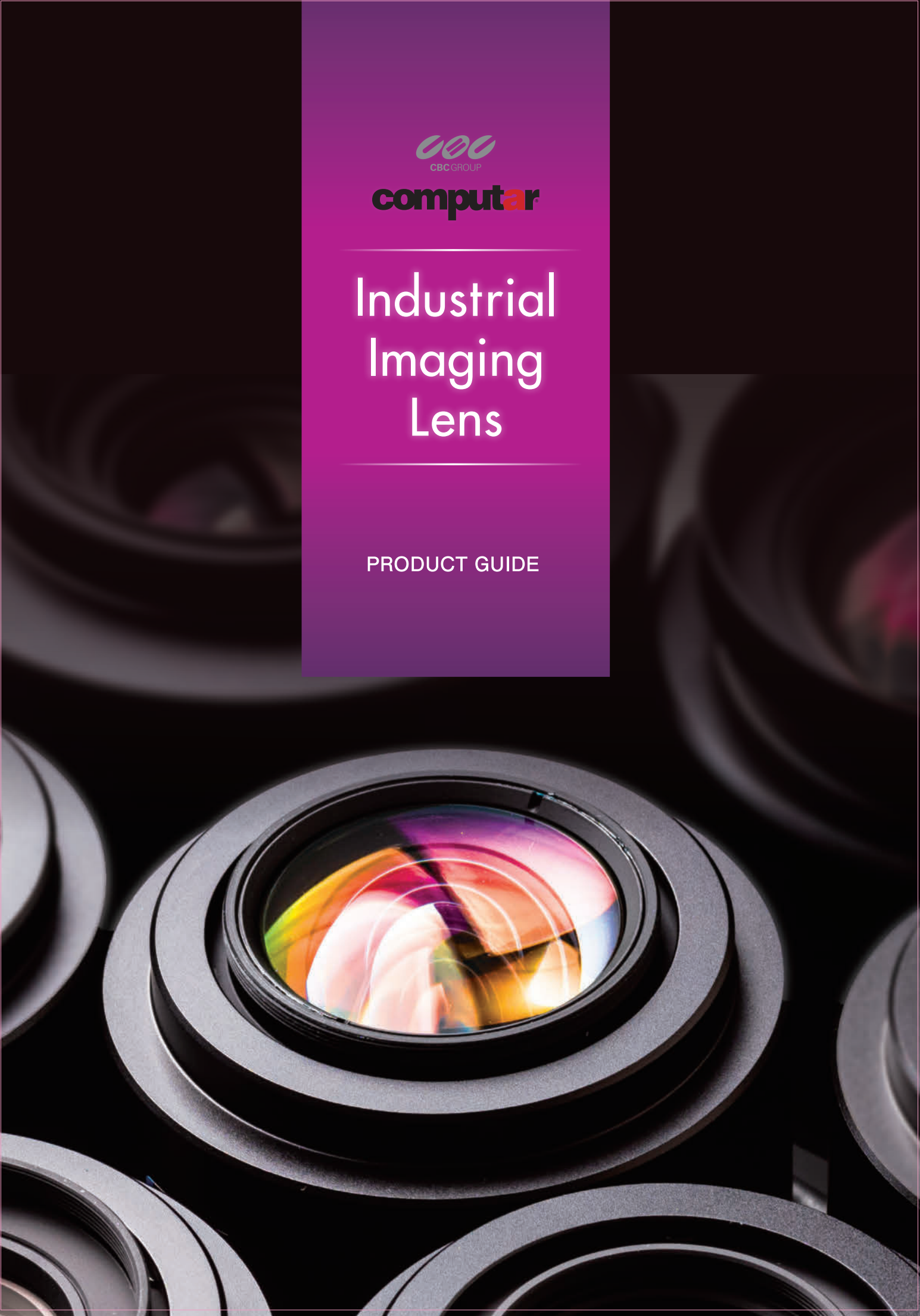

computar

Industrial Imaging Lens

PRODUCT GUIDE



BRAND PROMISE

As a Catalyst of Optics, Computar brings together diverse ideas and cutting-edge technology from multiple fields, developing innovations beyond any country's or industry's limitations.

Brand Story

As a Pioneer of Optics, Computar has set the standard. We excel by uniting our comprehensive production abilities, knowledge, interdisciplinary perspectives, and diverse specialties. We do this by discovering our evolving global society's constant and unexplored demands.

Our corporate origins date back one hundred years, with the last fifty in optics. We have developed a sustained ability to understand imaging applications and to engineer unique and innovative products. This ingenuity is the backbone of Computar's growth.

Computar has set the pace for developing intelligent, value-added,

high-performance industrial lenses with a solid foundation based on Japanese engineering. We have established enduring business partnerships and customer relationships in optics globally.

Computar's pioneering innovations result from the advancement of optics in analog and digital, security, and machine vision. Our hands-on knowledge, multiple collaborations, insight, and creativity make us who we are today.

Our optical science expertise in the advanced fields of 5G, IoT, and robotics enables us to respond to our customers' evolving demands globally. In addition, we actively promote technical liaisons beyond the borders of individual industries to deliver innovations based on a core of optical knowledge.

LensConnect TELECENTRIC Series

- The industry's first motorized telecentric lens
- New motorized lenses, enable power supply & control through USB (Available for I²C ver.)
- Maintain Telecentricity even during focus adjustment
- Ultra-high resolution lens (Compatible with 2.74 μ m pixel size)



LensConnect Series

- New motorized lenses, enable power supply & control through USB (Available for I²C ver.)
- Floating focus design achieves ultra-high resolution from near to far
- Stepper motors realizes precise focus control and high repeatability
- Easy-to-install by free control software
- 1" 20MP, Suitable for large format sensor (IMX183)



MPX Series

- Anti-vibration (10G) and shock resistance design (10G) to adapt to harsh inspection environments
- High-resolution lens 2 μ m or less pixel size supported
- Floating mechanism enables high performance from close-up to long distance
- Precise focus adjustment with a focus rotation angle 3 times greater than usual lenses
- Adoption of click-type iris mechanism
- Wide lineup of f=5.5mm/8mm/12mm/16mm/25mm/35mm/50mm/75mm



ViSWIR Series

- Dedicated design for next generation Visible+SWIR image sensor (IMX992/IMX993)
- Hyper Apochromat design, Fully corrected focus-shift between 400nm-1700nm
- Floating-focus mechanism realizes axial chromatic aberration and chromatic aberration of magnification at all WD and wavelength
- High transmittance at whole wavelength of 400nm-1700nm by adopting hyper wideband AR coat
- Minimize light scattering and clear images by adopting NIR absorbing coat



INDEX

NEW 03-04	REMOTE CONTROL MACHINE VISION LENS Lens  I ² C TELECENTRIC Series	33-34	 Hyper APO Series
NEW 05-06	REMOTE CONTROL MACHINE VISION LENS Lens  I ² C DL -MPY Series	35-36	 Lite Series
NEW 07-08	REMOTE CONTROL MACHINE VISION LENS Lens  I ² C VARI-FOCAL Series	NEW 37-38	 Lens  Series
NEW 09-10	REMOTE CONTROL MACHINE VISION LENS Lens  I ² C VL -MPZ Series	39	MACRO ZOOM LENS
NEW 11-12	REMOTE CONTROL MACHINE VISION LENS Lens  USB TELECENTRIC Series	40	TELECENTRIC MACRO LENS
13-14	REMOTE CONTROL MACHINE VISION LENS Lens  USB DL-MPY Series	41	1.1" 12MP 1" 5MP TELECENTRIC LENS (TEC-V Series)
15-16	REMOTE CONTROL MACHINE VISION LENS Lens  USB VARI-FOCAL Series	42-44	2/3" 2MP TELECENTRIC LENS (TEC-M Series)
17-18	REMOTE CONTROL MACHINE VISION LENS Lens  USB VL-MPZ Series	45-46	1.1" 12MP IR CORRECTIVE 12 MEGAPIXEL LENS for ITS (MPYIR Series)
NEW 19-20	REMOTE CONTROL MACHINE VISION LENS Lens  I ² C/USB ITS Series	47-48	2/3" 5MP IR CORRECTIVE 5 MEGAPIXEL LENS for ITS (MPIR Series)
21-22	1.4" 50MP LENS (MPT Series)	NEW 49	MEGAPIXEL BOARD LENS
23-24	1.1" 24MP LENS (MPY Series)	50	ACCESSORIES
25-26	1" 20MP LENS (MPZ Series)	NEW 51	RUGGEDIZED Series
NEW 27-28	2/3" 16MP LENS (MPX Series)	52	SECURITY LENS
29-30	2/3" 6MP LENS (MPW3 Series)	53-54	TECHNICAL INFORMATION
31-32	2/3" 1.5MP LENS (MP2 Series)	55-64	FIELD OF VIEW
		66	CBC WORLDWIDE NETWORK

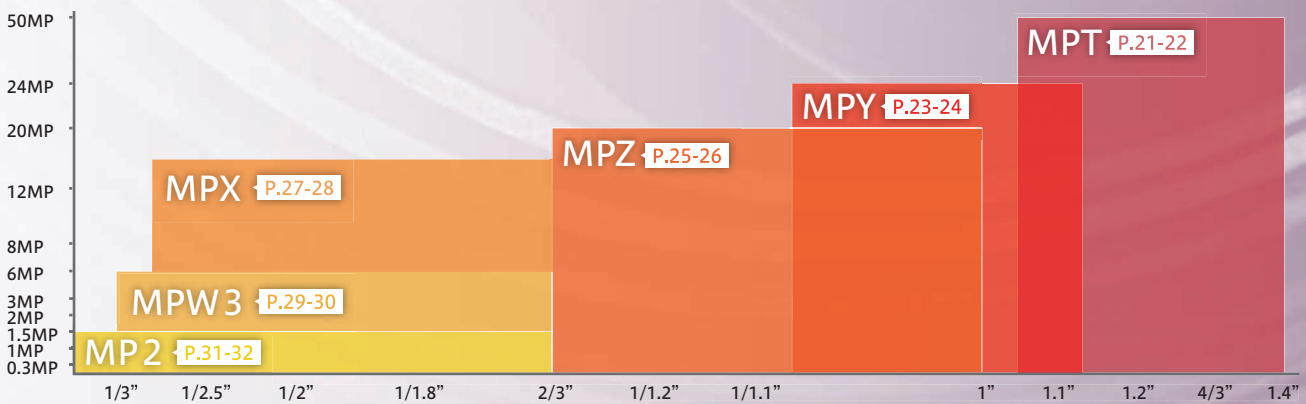

NEW LensConnect

I²C TELECENTRIC Series

LensConnect I²C TELECENTRIC Series



Model No.	Format	Optical Magnification	Adjustable Working Distance	Weight
TEC-ML025139SC-MPW	2/3"	0.25x	119mm - 159mm	334g
TEC-ML05132SC-MPW		0.5x	122mm - 142mm	310g
TEC-ML10110SC-MPW		1.0x	102.5mm - 117.5mm	328g
TEC-ML2071SC-MPW		2.0x	66mm - 76mm	394g

TEC-ML025139SC-MPW

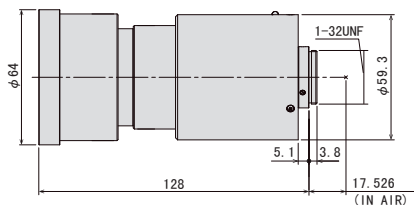

TEC-ML05132SC-MPW

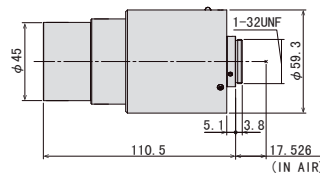

Max. Image Circle	φ11.4mm		φ11.4mm	
Optical Magnification	0.25x		0.5x	
Adjustable Working Distance	119mm - 159mm		122mm - 142mm	
Resolving Power *1	17.7μm		8.6μm	
Depth of Field *2	8.32mm		2.08mm	
NA	0.019		0.039	
Control	Focus	Motorized		Motorized
Field of View	D	44.0mm	2/3"	22.0mm
	H	35.2mm	2/3"	17.6mm
	V	26.4mm	2/3"	13.2mm
Operating temperature	-20°C - +60°C		-20°C - +60°C	
Effective F-number	6.5		6.5	

TV Distortion	2/3"	-0.16%	2/3"	-0.01%
Back Focal Length	17.1mm (In Air)		17.0mm (In Air)	
Flange Back Length	17.526mm (In Air)		17.526mm (In Air)	
Mount	C-Mount		C-Mount	
Filter thread	M62 P=0.75mm		M43 P=0.75mm	
Weight	334g		310g	

Control Interface	I ² C		I ² C	
Power mode	DC5.0V±10%(500mA max)		DC5.0V±10%(500mA max)	
Connector	-		-	

*1:Resolving power = 0.61xλ / NA (λ=550nm) *2:Depth of Field = 2x(Permissible circle of confusion[40um] × Effective F-number / Magnification^2)

- The industry's first motorized telecentric lens
- New motorized lenses, enable power supply & control through USB (Available for I2C ver.)
- Maintain Telecentricity even during focus adjustment
- Ultra-high resolution lens (Compatible with 2.74μm pixel size)

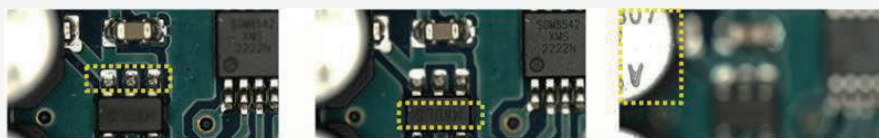

Instantly adjusts to the optimal focus position, even for workpieces with varying heights.

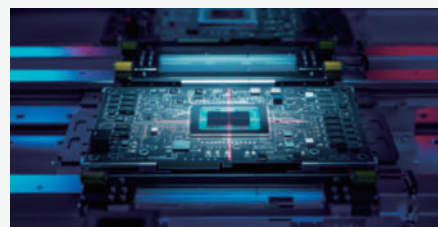

TEC-ML10110SC-MPW

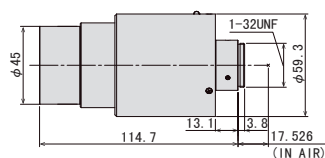

TEC-ML2071SC-MPW

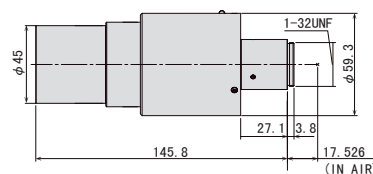

Max. Image Circle	φ11.4mm		φ11.4mm	
Optical Magnification	1.0x		2.0x	
Adjustable Working Distance	102.5mm - 117.5mm		66mm - 76mm	
Resolving Power *1	4.4 μm		2.2 μm	
Depth of Field *2	0.52mm		0.13mm	
NA	0.077		0.154	
Control	Focus	Motorized		Motorized
Field of View	D	11.0mm		
	H	2/3" 8.8mm	2/3"	5.5mm
	V	6.6mm		4.4mm
Operating temperature	-20°C - +60°C		-20°C - +60°C	
Effective F-number	6.5		6.5	

TV Distortion	2/3"	0.02%	2/3"	0.01%
Back Focal Length	17.1mm (In Air)		17.1mm (In Air)	
Flange Back Length	17.526mm (In Air)		25.3mm (In Air)	
Mount	C-Mount		C-Mount	
Filter thread	M43 P=0.75mm		M43 P=0.75mm	
Weight	328g		394g	

Control Interface	I ² C		I ² C	
Power mode	DC5.0V±10%(500mA max)		DC5.0V±10%(500mA max)	
Connector	-		-	

NEW LensConnect

I²C DL-MPY Series

LensConnect I²C DL -MPY Series



Model No.	Format	Focal Length	F No.	Working Distance	Weight
DL0828SC-MPY	1/1.1"	8mm	F2.8	0.1m-Inf.	170g
DL1224SC-MPY		12mm	F2.4	0.1m-Inf.	155g
DL1623SC-MPY		16mm	F2.3	0.11m-Inf.	165g
DL2523SC-MPY		25mm	F2.3	0.12m-Inf.	158g
DL3525SC-MPY		35mm	F2.5	0.16m-Inf.	152g
DL5028SC-MPY		50mm	F2.8	0.2m-Inf.	165g

DL0828SC-MPY

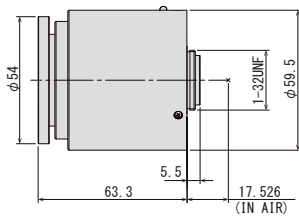

DL1224SC-MPY

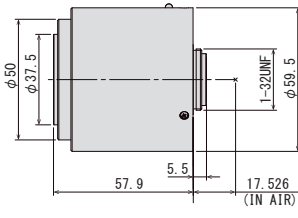

DL1623SC-MPY

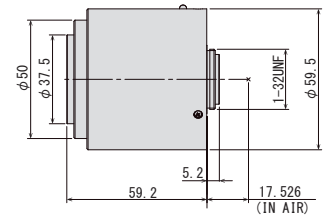

Focal Length	8mm					12mm					16mm								
Max. Image Format	φ 14.4mm					φ 14.4mm					φ 14.4mm								
Operation Range	Iris	F2.8 - F16.0					F2.4 - F16.0					F2.3 - F16.0							
	Focus	0.1m - Inf.					0.1m - Inf.					0.11m - Inf.							
Control	Iris	Motorized					Motorized					Motorized							
	Focus	Motorized					Motorized					Motorized							
Angle of View	D	80.4°		68.3°		58.1°		60.2°		49.7°		41.5°		47.0°		38.2°		31.6°	
	H	1/1.1"	69.4°	2/3"	57.0°	1/1.8"	47.8°	1/1.1"	50.5°	2/3"	40.6°	1/1.8"	33.6°	1/1.1"	38.9°	2/3"	31.0°	1/1.8"	25.5°
	V	53.8°		44.1°		36.6°		38.1°		31.0°		25.5°		29.0°		23.4°		19.2°	
Operating Temperature	-20°C - +60°C					-20°C - +60°C					-20°C - +60°C								

Optical Distortion	1/1.1"	0.0%	2/3"	-1.6%	1/1.8"	-1.7%	1/1.1"	-0.1%	2/3"	-1.0%	1/1.8"	-1.0%	1/1.1"	0.0%	2/3"	-0.7%	1/1.8"	-0.7%
Back Focal Length	13.0mm (In Air)						14.6mm (In Air)						14.3mm (In Air)					
Flange Back Length	17.526mm (In Air)						17.526mm (In Air)						17.526mm (In Air)					
Mount	C-Mount						C-Mount						C-Mount					
Filter Size	M52 P=0.75mm						M35.5 P=0.5mm						M35.5 P=0.5mm					
Weight	170g						155g						165g					

Control Interface	I ² C						I ² C						I ² C					
Power mode	DC5.0V±10%(500mA max)						DC5.0V±10%(500mA max)						DC5.0V±10%(500mA max)					
Connector	-						-						-					

- Motorized lenses controllable via the I2C interface
- Motorized lenses that can be easily operated from compatible cameras, enabling remote control of focus and iris
- Focus control through a high-speed and stable interface
- Ultra-high-resolution fixed-focal-length lenses supporting 1/1.1" 12-megapixel sensors
- Ultra-low-distortion design suitable for a wide range of machine vision applications

1/1.1"

12MP

MOTORIZED

I²C

FIX

FLOATING

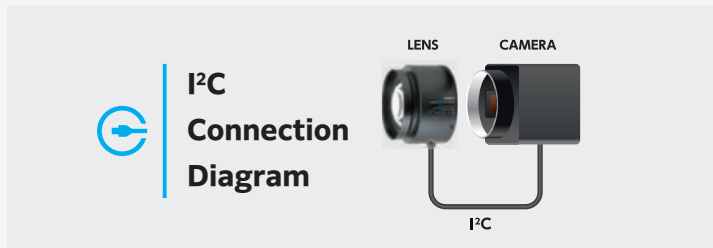

DL2523SC-MPY

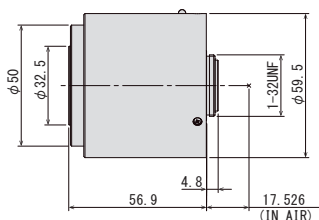

DL3525SC-MPY

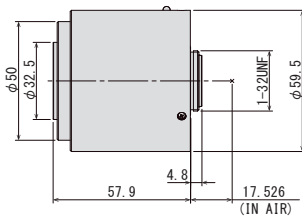

DL5028SC-MPY

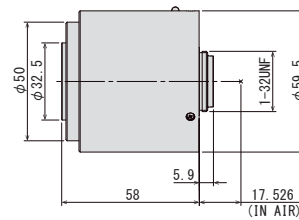

Focal Length	25mm					35mm					50mm								
Max. Image Format	φ 14.4mm					φ 14.4mm					φ 14.4mm								
Operation Range	Iris	F2.3 - F16.0					F2.5 - F16.0					F2.8 - F16.0							
	Focus	0.12m - Inf.					0.16m - Inf.					0.2m - Inf.							
Control	Iris	Motorized					Motorized					Motorized							
	Focus	Motorized					Motorized					Motorized							
Angle of View	D		31.0°		24.8°		20.4°		22.5°		17.9°		14.7°		16.3°		12.9°		10.6°
	H	1/1.1"	25.3°	2/3"	20.0°	1/1.8"	16.4°	1/1.1"	18.2°	2/3"	14.3°	1/1.8"	11.7°	1/1.1"	13.2°	2/3"	10.4°	1/1.8"	8.5°
	V		18.7°		15.1°		12.3°		13.4°		10.8°		8.8°		9.7°		7.8°		6.4°
Operating Temperature	-20°C - +60°C					-20°C - +60°C					-20°C - +60°C								

Optical Distortion	1/1.1"	0.1%	2/3"	-0.1%	1/1.8"	-0.1%	1/1.1"	0.0%	2/3"	0.0%	1/1.8"	0.0%	1/1.1"	0.0%	2/3"	0.0%	1/1.8"	0.0%
Back Focal Length	14.3mm (In Air)						14.3mm (In Air)						14.2mm (In Air)					
Flange Back Length	17.526mm (In Air)						17.526mm (In Air)						17.526mm (In Air)					
Mount	C-Mount						C-Mount						C-Mount					
Filter Size	M30.5 P=0.5mm						M30.5 P=0.5mm						M30.5 P=0.5mm					
Weight	158g						152g						165g					

Control Interface	I ² C						I ² C						I ² C					
Power mode	DC5.0V±10%(500mA max)						DC5.0V±10%(500mA max)						DC5.0V±10%(500mA max)					
Connector	-						-						-					

NEW LensConnect

I²C VARI-FOCAL Series

LensConnect I²C VARI-FOCAL Series



Model No.	Format	Focal Length	F No.	Resolution	Working Distance	Weight
VL6Z1626SC-MPYIR	1.1"	16-96mm	F2.6	12MP	3m-Inf.	322g
VL2Z2533SM6C-MPWIR	1"	25-50mm	F3.3	9MP	WIDE : 1m-Inf TELE : 3m-Inf	261g
ML3Z1226SC-MPW	2/3"	12-36mm	F2.6	9MP	WIDE : 0.1m-Inf TELE : 0.35m-Inf	239g
ML2Z0525SC-MPWIR	2/3"	5.5-12.7mm	F2.5	9MP	0.1m-Inf.	164g
EL3Z0416SC-MPWIR	1/1.8"	4-10mm	F1.6	5MP	0.2m-Inf.	153g
EL6Z0915SC-MPWIR	1/1.8"	9-50mm	F1.5	5MP	3m-Inf.	291g

VL6Z1626SC-MPYIR

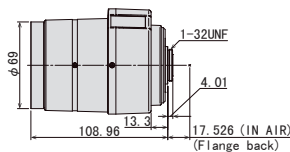

VL2Z2533SM6C-MPWIR

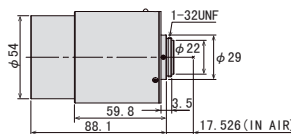

ML3Z1226SC-MPW

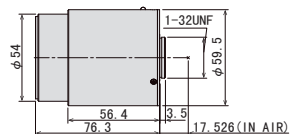

Focal Length	16mm - 96mm					25mm - 50mm					12mm - 36mm								
Max. Image Format	14.2mm × 10.4mm (φ 17.6mm)					φ 16.0mm					φ 11.8mm								
Operation Range	Iris	WIDE : F2.6 - F16.0 TELE : F2.7 - F16.0					WIDE : F3.3 - F16.0 TELE : F3.4 - F16.0					F2.6 - F16.0							
	Focus	3m - Inf.					WIDE : 1m - Inf. TELE : 3m - Inf.					WIDE : 0.1m - Inf. TELE : 0.35m - Inf.							
Control	Iris	Motorized					Motorized					Motorized							
	Focus	Motorized					Motorized					Motorized							
	Zoom	Motorized					Motorized					Motorized							
Angle of View	D	1.1"	58.9° - 10.4°	1"	54.1° - 9.5°	2/3"	37.8° - 6.7°	1"	35.9° - 18.3°	2/3"	24.7° - 12.7°	1/1.8"	20.3° - 10.4°	2/3"	50.4° - 16.9°	1/1.8"	42.0° - 14.0°	1/3"	28.4° - 9.5°
	H		48.1° - 8.5°		48.1° - 8.5°		30.3° - 5.4°		28.8° - 14.7°		19.8° - 10.2°		16.2° - 8.3°		41.1° - 13.7°		33.9° - 11.3°		22.8° - 7.6°
	V		35.6° - 6.3°		25.7° - 4.5°		22.8° - 4.0°		21.6° - 11.1°		14.9° - 7.7°		12.2° - 6.3°		31.2° - 10.4°		25.6° - 8.5°		17.1° - 5.7°
Operating Temperature	-20°C - +60°C					-20°C - +60°C					-20°C - +60°C								

Back Focal Length	WIDE	13.9mm (In Air)					15.0 mm (in Air)					16.4 mm (In Air)				
	TELE	13.9mm (In Air)					16.2 mm (in Air)					15.9 mm (In Air)				
Flange Back Length	17.526mm (In Air)					17.526mm (In Air)					17.526mm (In Air)					
Mount	C-Mount					C-Mount					C-Mount					
Filter Size	M67 P=0.75mm					M52 x P0.75mm					M49 P=0.75mm					
Tripod Screw	1/4-20UNC															
Weight	322g					261g					239g					

Control Interface	I ² C					I ² C					I ² C				
Power mode	DC5.0V±10%(500mA max)					DC5.0V±10%(500mA max)					DC5.0V±10%(500mA max)				
Connector	-					-					-				

- Motorized lenses controllable via the I2C interface
- Motorized lenses that can be easily operated from compatible cameras, enabling remote control of zoom, focus, and iris
- High-speed focus control with excellent repeatability
- Ultra-high-resolution varifocal lenses compatible with 1.1-inch 12-megapixel sensors, as well as 1-inch, 2/3-inch, and 1/1.8-inch formats



ML3Z1226SC-MPW

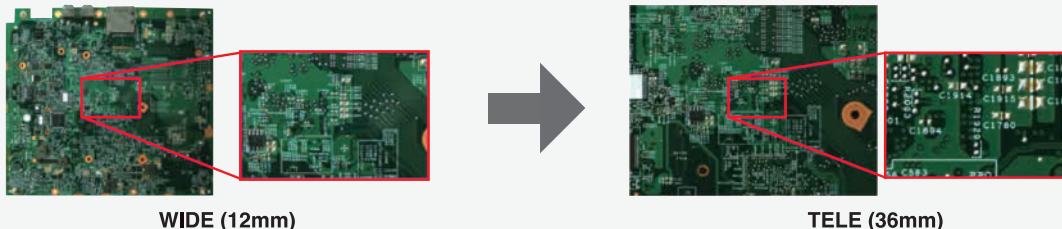

ML2Z0525SC-MPWIR

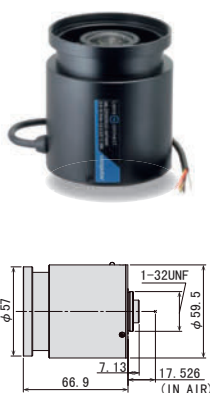

EL3Z0416SCS-MPWIR

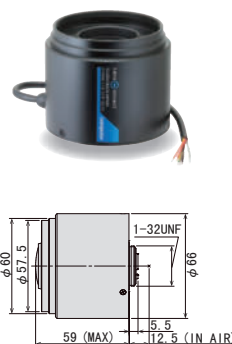

EL6Z0915SCS-MPWIR

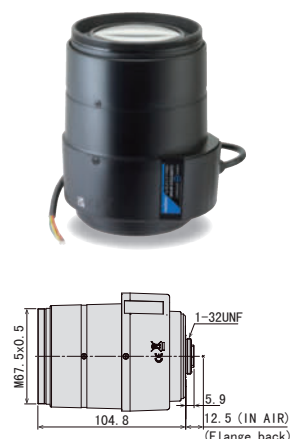

Focal Length	5.5mm - 12.7mm					4mm - 10mm					9mm - 50mm								
Max. Image Format	φ 11.8mm					7.1mm × 5.4mm (φ 8.9mm)					7.1mm × 5.4mm (φ 8.9mm)								
Operation Range	iris	WIDE: F2.5 - F16.0 TELE: F3.7 - F16.0					WIDE: F1.6 - F16.0 TELE: F2.7 - F16.0					WIDE: F1.5 - F16.0 TELE: F1.6 - F16.0							
	Focus	0.1m - Inf.					0.2m - Inf.					3m - Inf.							
Control	iris	Motorized					Motorized					Motorized							
	Focus	Motorized					Motorized					Motorized							
	Zoom	Motorized					Motorized					Motorized							
Angle of View	D	105.2° - 49.6°		87.8° - 41.0°		59.8° - 27.6°		138.1° - 52.9°		120.3° - 47.5°		86.5° - 35.5°		52.5° - 10.2°		47.4° - 9.2°		35.9° - 7.0°	
	H	2/3" 86.0° - 40.1°		1/1.8" 71.3° - 33.0°		1/3" 48.1° - 22.2°		1/1.8" 104.8° - 42.2°		1/2" 92.9° - 37.9°		1/3" 68.1° - 28.4°		1/1.8" 42.3° - 8.2°		1/2" 38.2° - 7.5°		1/3" 28.8° - 5.7°	
	V	65.6° - 30.3°		54.0° - 24.9°		36.3° - 16.7°		76.3° - 31.6°		68.1° - 28.4°		50.5° - 21.3°		32.4° - 6.3°		28.8° - 5.7°		21.7° - 4.3°	
Operating Temperature	-20°C - +60°C					-20°C - +60°C					-20°C - +60°C								

Back Focal Length	WIDE	11.4mm (In Air)					8.5mm (In Air)					9.2mm (In Air)				
	TELE	11.4mm (In Air)					8.5mm (In Air)					9.2mm (In Air)				
Flange Back Length	17.526mm (In Air)					12.5mm (In Air)					12.5mm (In Air)					
Mount	C-Mount					CS-Mount					CS-Mount					
Filter Size	M55 P=0.75mm					M55 P=0.75mm (With VM0418)*					M67 P=0.75mm (With VM0918)*					
Tripod Screw											1/4-20UNC					
Weight	164g					153g					291g					

Control Interface	I ² C					I ² C					I ² C				
Power mode	DC5.0V±10%(500mA max)					DC5.0V±10%(500mA max)					DC5.0V±10%(500mA max)				
Connector	-					-					-				

*When using filters, lens requires VM0418 (sold separately). For more detail please refer to P.50

*When using filters, lens requires VM0918 (sold separately). For more detail please refer to P.50

I²C VL-MPZ Series

LensConnect I²C VL -MPZ Series



Model No.	Format	Focal Length	F No.	Working Distance	Weight
VL0826U-MPZ	1"	8mm	F2.6	0.1m-Inf.	326g
VL1226U-MPZ		12mm	F2.6	0.1m-Inf.	265g
VL1624U-MPZ		16mm	F2.4	0.1m-Inf.	272g
VL2520U-MPZ		25mm	F2.0	0.15m-Inf.	249g
VL3522U-MPZ		35mm	F2.2	0.2m-Inf.	305g
VL5024U-MPZ		50mm	F2.4	0.2m-Inf.	318g
VL7531U-MPZ		75mm	F3.1	0.25m-Inf.	407g

VL0826U-MPZ

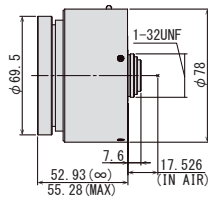

VL1226U-MPZ

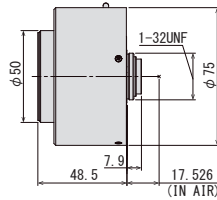

VL1624U-MPZ

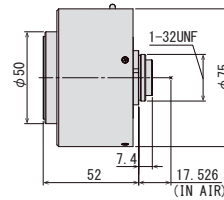

VL2520U-MPZ

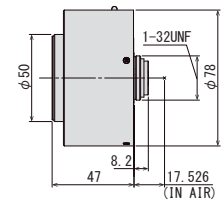

Focal Length	8mm					12mm					16mm					25mm							
Max. Aperture Ratio	1:2.6					1:2.6					1:2.4					1:2.0							
Max. Image Format	12.8mm × 9.6mm (φ 16mm)																						
Operation Range	Iris	F2.6 - F16.0					F2.6 - F16.0					F2.4 - F16.0					F2.0 - F16.0						
	Focus	0.1m - Inf.					0.1m - Inf.					0.1m - Inf.					0.15m - Inf.						
Control	Iris	Motorized					Motorized					Motorized					Motorized						
	Focus	Motorized					Motorized					Motorized					Motorized						
Angle of View	D	88.8°					67.4°					53.2°					35.5°						
	H	1"	2/3"	1/1.8"	1/1.8"	1/1.8"	1"	2/3"	1/1.8"	1/1.8"	1"	2/3"	1/1.8"	1/1.8"	1"	2/3"	1/1.8"	1/1.8"					
	V	76.9°	57.1°	47.8°	44.2°	36.6°	56.7°	40.7°	33.7°	44.1°	31.0°	25.5°	43.8°	30.9°	25.5°	33.6°	23.4°	19.2°	28.8°	20.0°	16.4°	21.8°	15.1°
Operating Temperature	-10° C - +50° C					-10° C - +50° C					-10° C - +50° C					-10° C - +50° C							

Optical Distortion	1"	-0.8%	2/3"	-2.1%	1/1.8"	-1.9%	1"	0.0%	2/3"	-1.1%	1/1.8"	-1.0%	1"	0.0%	2/3"	-0.4%	1/1.8"	-0.4%	1"	0.0%	2/3"	0.0%	1/1.8"	0.0%
Back Focal Length	10.6mm (In Air)						10.6mm (In Air)						10.7mm (In Air)						9.1mm (In Air)					
Flange Back Length	17.526mm (In Air)						17.526mm (In Air)						17.526mm (In Air)						17.526mm (In Air)					
Mount	C-Mount																							
Filter Size	M82 P=0.75mm (With ZM0810)*						M46 P=0.75mm						M43 P=0.75mm						M46 P=0.75mm					
Weight	326g					265g					272g					249g								

Control Interface	I ² C					I ² C					I ² C					I ² C				
Power mode	DC5.0V±10%(500mA max)																			
Connector	-																			

*When using filters, lens requires ZM0810 (sold separately).
For more detail please refer to P.50

- Motorized lenses controllable via the I²C interface
- Motorized lenses that can be easily operated from compatible cameras, enabling remote control of focus and iris
- Ultra-high resolution lens, suitable for 1" 20 megapixel sensor
- Much lower distortion design for all models is beneficial for a variety of machine vision applications
- Has the newest optical design, which has a much higher relative illuminance compared to conventional models, despite having a large format 1" sensor (Ø16mm)

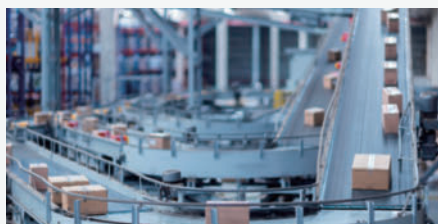
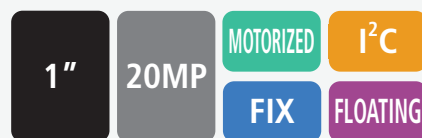

High-Precision Vision for Accurate Logistic Monitoring.



High-Precision Inspection for Accurate Assembly Line Quality.



Supporting Accurate Inspection in Assembly Processes.

VL3522U-MPZ

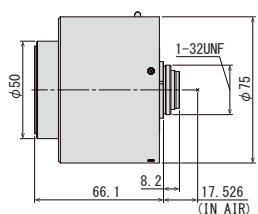

VL5024U-MPZ

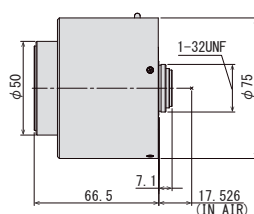

VL7531U-MPZ

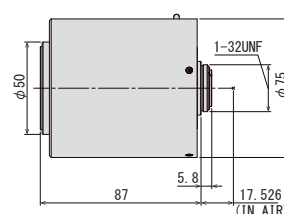

Focal Length		35mm						50mm						75mm					
Max. Aperture Ratio		1:2.2						1:2.4						1:3.1					
Max. Image Format		12.8mm × 9.6mm (φ 16mm)						12.8mm × 9.6mm (φ 16mm)						12.8mm × 9.6mm (φ 16mm)					
Operation Range	Iris	F2.2 - F16.0						F2.4 - F16.0						F3.1 - F16.0					
	Focus	0.2m - Inf.						0.2m - Inf.						0.25m - Inf.					
Control	Iris	Motorized						Motorized						Motorized					
	Focus	Motorized						Motorized						Motorized					
Angle of View	D	1"	25.8°	2/3"	17.9°	1/1.8"	14.7°	1"	18.2°	2/3"	12.6°	1/1.8"	10.3°	1"	12.2°	2/3"	8.4°	1/1.8"	6.9°
	H		20.8°		14.4°		11.8°		14.6°		10.1°		8.3°		9.8°		6.7°		5.5°
	V		15.7°		10.8°		8.9°		11.0°		7.6°		6.2°		7.3°		5.0°		4.1°
Operating Temperature		-10° C - +50° C						-10° C - +50° C						-10° C - +50° C					

Optical Distortion	1"	0.0%	2/3"	0.0%	1/1.8"	0.0%	1"	0.0%	2/3"	0.0%	1/1.8"	0.0%	1"	0.0%	2/3"	0.0%	1/1.8"	0.0%
Back Focal Length	9.7mm (In Air)						11.1mm (In Air)						12.0mm (In Air)					
Flange Back Length	17.526mm (In Air)						17.526mm (In Air)						17.526mm (In Air)					
Mount	C-Mount						C-Mount						C-Mount					
Filter Size	M43 P=0.75mm						M43 P=0.75mm						M43 P=0.75mm					
Weight	305g						318g						407g					

Control Interface	I ² C						I ² C						I ² C					
Power mode	DC5.0V±10%(500mA max)						DC5.0V±10%(500mA max)						DC5.0V±10%(500mA max)					
Connector	-						-						-					

NEW LensConnect

USB TELECENTRIC Series

LensConnect USB TELECENTRIC Series



Model No.	Format	Optical Magnification	Adjustable Working Distance	Weight
TEC-ML025139UC-MPW	2/3"	0.25x	119mm - 159mm	342g
TEC-ML05132UC-MPW		0.5x	122mm - 142mm	318g
TEC-ML10110UC-MPW		1.0x	102.5mm - 117.5mm	336g
TEC-ML2071UC-MPW		2.0x	66mm - 76mm	402g

TEC-ML025139UC-MPW

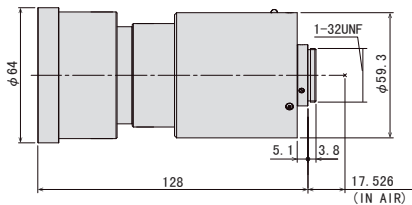

TEC-ML05132UC-MPW

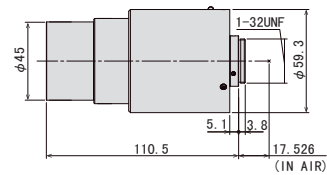

Max. Image Circle	φ11.4mm		φ11.4mm	
Optical Magnification	0.25x		0.5x	
Adjustable Working Distance	119mm - 159mm		122mm - 142mm	
Resolving Power *1	17.7μm		8.6μm	
Depth of Field *2	8.32mm		2.08mm	
NA	0.019		0.039	
Control	Focus	Motorized	Motorized	
Field of View	D	44.0mm	22.0mm	
	H	2/3"	35.2mm	17.6mm
	V	26.4mm	13.2mm	
Operating temperature	-20°C - +60°C		-20°C - +60°C	
Effective F-number	6.5		6.5	

TV Distortion	2/3"	-0.16%	2/3"	-0.01%
Back Focal Length	17.1mm (In Air)		17.0mm (In Air)	
Flange Back Length	17.526mm (In Air)		17.526mm (In Air)	
Mount	C-Mount		C-Mount	
Filter thread	M62 P=0.75mm		M43 P=0.75mm	
Weight	342g		318g	

Control Interface	USB2.0		USB2.0	
Power mode	Bus power(5V:500mA)		Bus power(5V:500mA)	
Connector	USB TypeA		USB TypeA	

*1:Resolving power = $0.61 \times \lambda / NA$ ($\lambda = 550\text{nm}$) *2:Depth of Field = $2x$ (Permissible circle of confusion [40μm] × Effective F-number / Magnification²)

- The industry's first motorized telecentric lens
- New motorized lenses, enable power supply & control through USB (Available for I2C ver.)
- Maintain Telecentricity even during focus adjustment
- Ultra-high resolution lens (Compatible with 2.74um pixel size)

2/3"

8MP

MOTORIZED

TELECEN

USB

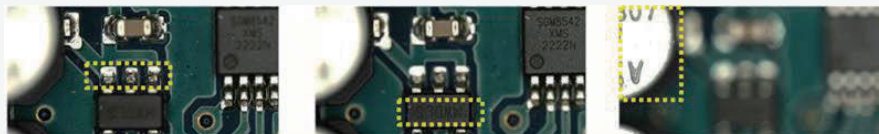

Instantly adjusts to the optimal focus position, even for workpieces with varying heights.

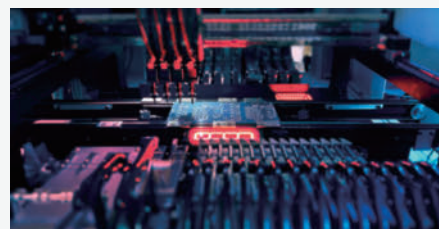

TEC-ML10110UC-MPW

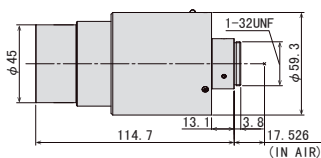

TEC-ML2071UC-MPW

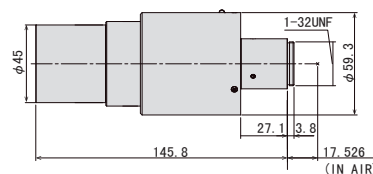

Max. Image Circle	φ11.4mm		φ11.4mm	
Optical Magnification	1.0x		2.0x	
Adjustable Working Distance	102.5mm - 117.5mm		66mm - 76mm	
Resolving Power *1	4.4 μm		2.2 μm	
Depth of Field *2	0.52mm		0.13mm	
NA	0.077		0.154	
Control	Focus	Motorized	Motorized	
Field of View	D	11.0mm	5.5mm	
	H	2/3" 8.8mm	2/3" 4.4mm	
	V	6.6mm	3.3mm	
Operating temperature	-20°C - +60°C		-20°C - +60°C	
Effective F-number	6.5		6.5	

TV Distortion	2/3"	0.02%	2/3"	0.01%
Back Focal Length	17.1mm (In Air)		17.1mm (In Air)	
Flange Back Length	17.526mm (In Air)		25.3mm (In Air)	
Mount	C-Mount		C-Mount	
Filter thread	M43 P=0.75mm		M43 P=0.75mm	
Weight	336g		402g	

Control Interface	USB2.0		USB2.0	
Power mode	Bus power(5V:500mA)		Bus power(5V:500mA)	
Connector	USB TypeA		USB TypeA	

USB DL-MPY Series

LensConnect USB TELECENTRIC Series



Model No.	Format	Focal Length	F No.	Working Distance	Weight
DL0828UC-MPY	1/1.1"	8mm	F2.8	0.1m-Inf.	178g
DL1224UC-MPY		12mm	F2.4	0.1m-Inf.	163g
DL1623UC-MPY		16mm	F2.3	0.11m-Inf.	173g
DL2523UC-MPY		25mm	F2.3	0.12m-Inf.	166g
DL3525UC-MPY		35mm	F2.5	0.16m-Inf.	160g
DL5028UC-MPY		50mm	F2.8	0.2m-Inf.	173g

DL0828UC-MPY

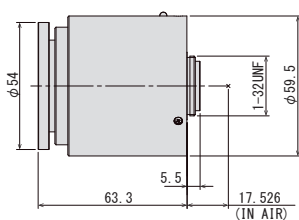

DL1224UC-MPY

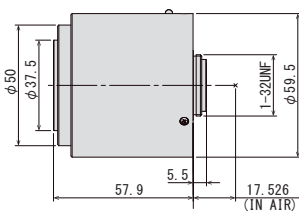

DL1623UC-MPY

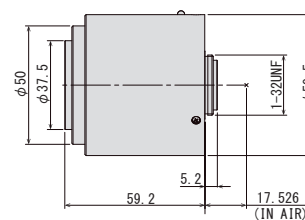

Focal Length	8mm						12mm						16mm						
Max. Image Format	φ 14.4mm						φ 14.4mm						φ 14.4mm						
Operation Range	Iris F2.8 - F16.0						Iris F2.4 - F16.0						Iris F2.3 - F16.0						
	Focus 0.1m - Inf.						Focus 0.1m - Inf.						Focus 0.11m - Inf.						
Control	Iris Motorized						Iris Motorized						Iris Motorized						
	Focus Motorized						Focus Motorized						Focus Motorized						
Angle of View	D	80.4°		68.3°		58.1°		60.2°		49.7°		41.5°		47.0°		38.2°		31.6°	
	H	1/1.1"	69.4°	2/3"	57.0°	1/1.8"	47.8°	1/1.1"	50.5°	2/3"	40.6°	1/1.8"	33.6°	1/1.1"	38.9°	2/3"	31.0°	1/1.8"	25.5°
	V	53.8°		44.1°		36.6°		38.1°		31.0°		25.5°		29.0°		23.4°		19.2°	
Operating Temperature	-20°C - +60°C						-20°C - +60°C						-20°C - +60°C						

Optical Distortion	1/1.1"	0.0%	2/3"	-1.6%	1/1.8"	-1.7%	1/1.1"	-0.1%	2/3"	-1.0%	1/1.8"	-1.0%	1/1.1"	0.0%	2/3"	-0.7%	1/1.8"	-0.7%
Back Focal Length	13.0mm (In Air)						14.6mm (In Air)						14.3mm (In Air)					
Flange Back Length	17.526mm (In Air)						17.526mm (In Air)						17.526mm (In Air)					
Mount	C-Mount						C-Mount						C-Mount					
Filter Size	M52 P=0.75mm						M35.5 P=0.5mm						M35.5 P=0.5mm					
Weight	178g						163g						173g					

Control Interface	USB2.0						USB2.0						USB2.0					
Power mode	Bus power(5V:500mA)						Bus power(5V:500mA)						Bus power(5V:500mA)					
Connector	USB TypeA						USB TypeA						USB TypeA					

- Motorized lenses controllable via the USB interface
- Motorized lenses that can be easily operated from compatible cameras, enabling remote control of focus and iris
- Focus control through a high-speed and stable interface
- Ultra-high-resolution fixed-focal-length lenses supporting 1/1.1" 12-megapixel sensors
- Ultra-low-distortion design suitable for a wide range of machine vision applications

1/1.1"

12MP

MOTORIZED

USB

FIX

FLOATING

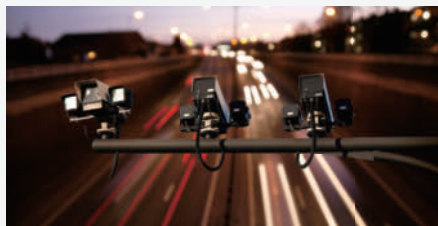

Remote adjustment in out-of-reach places

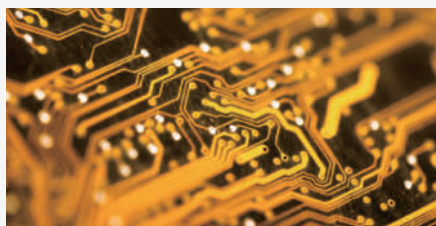

Make precise adjustments to lenses after installation

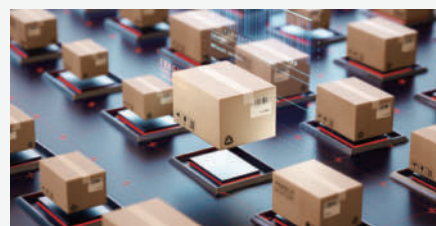

Easily change the focus point for workpieces at different heights

DL2523UC-MPY

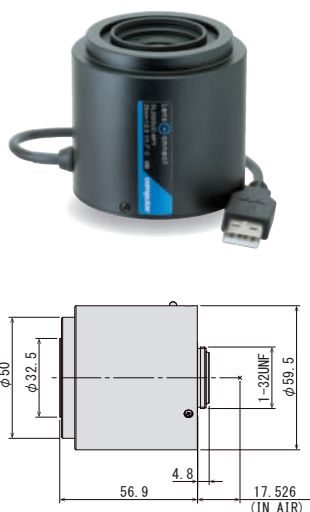

DL3525UC-MPY

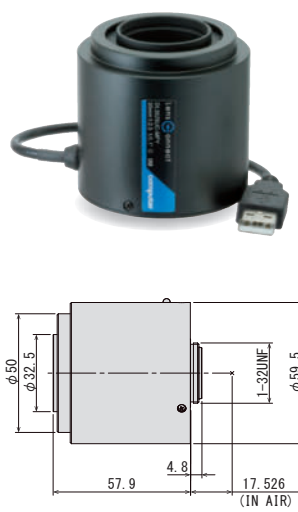

DL5028UC-MPY

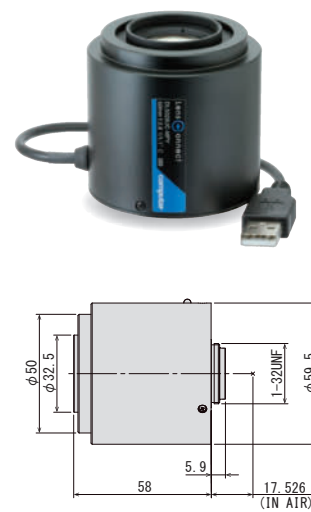

Focal Length	25mm					35mm					50mm								
Max. Image Format	φ 14.4mm					φ 14.4mm					φ 14.4mm								
Operation Range	Iris	F2.3 - F16.0				F2.5 - F16.0					F2.8 - F16.0								
	Focus	0.12m - Inf.				0.16m - Inf.					0.2m - Inf.								
Control	Iris	Motorized				Motorized					Motorized								
	Focus	Motorized				Motorized					Motorized								
Angle of View	D		31.0°		24.8°		20.4°		22.5°		17.9°		14.7°		16.3°		12.9°		10.6°
	H	1/1.1"	25.3°	2/3"	20.0°	1/1.8"	16.4°	1/1.1"	18.2°	2/3"	14.3°	1/1.8"	11.7°	1/1.1"	13.2°	2/3"	10.4°	1/1.8"	8.5°
	V		18.7°		15.1°		12.3°		13.4°		10.8°		8.8°		9.7°		7.8°		6.4°
Operating Temperature	-20°C - +60°C					-20°C - +60°C					-20°C - +60°C								

Optical Distortion	1/1.1"	0.1%	2/3"	-0.1%	1/1.8"	-0.1%	1/1.1"	0.0%	2/3"	0.0%	1/1.8"	0.0%	1/1.1"	0.0%	2/3"	0.0%	1/1.8"	0.0%
Back Focal Length	14.3mm (In Air)						14.3mm (In Air)						14.2mm (In Air)					
Flange Back Length	17.526mm (In Air)						17.526mm (In Air)						17.526mm (In Air)					
Mount	C-Mount						C-Mount						C-Mount					
Filter Size	M30.5 P=0.5mm						M30.5 P=0.5mm						M30.5 P=0.5mm					
Weight	166g						160g						173g					

Control Interface	USB2.0						USB2.0						USB2.0					
Power mode	Bus power(5V:500mA)						Bus power(5V:500mA)						Bus power(5V:500mA)					
Connector	USB TypeA						USB TypeA						USB TypeA					

USB VARI-FOCAL Series

LensConnect USB VARI-FOCAL Series



Model No.	Format	Focal Length	F No.	Resolution	Working Distance	Weight
VL6Z1626UC-MPYIR	1.1"	16-96mm	F2.6	12MP	3m-Inf.	330g
VL2Z2533UM6C-MPWIR	1"	25-50mm	F3.3	9MP	WIDE: 1m-Inf TELE: 3m-Inf	269g
ML3Z1226UC-MPW	2/3"	12-36mm	F2.6	9MP	WIDE:0.1m-Inf TELE:0.35m-Inf	247g
ML2Z0525UC-MPWIR	2/3"	5.5-12.7mm	F2.5	9MP	0.1m-Inf.	172g
EL3Z0416UCS-MPWIR	1/1.8"	4-10mm	F1.6	5MP	0.2m-Inf.	161g
EL6Z0915UCS-MPWIR	1/1.8"	9-50mm	F1.5	5MP	3m-Inf.	299g

VL6Z1626UC-MPYIR

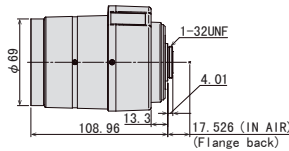

VL2Z2533UM6C-MPWIR

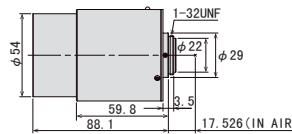

ML3Z1226UC-MPW

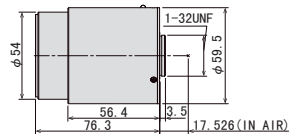

Focal Length	16mm - 96mm					25mm - 50mm					12mm - 36mm																	
Max. Image Format	14.2mm × 10.4mm (φ 17.6mm)					φ 16.0mm					φ 11.8mm																	
Operation Range	Iris	WIDE:F2.6 - F16.0 TELE:F2.7 - F16.0					WIDE:F3.3 - F16.0 TELE:F3.4 - F16.0					F2.6 - F16.0																
	Focus	3m - Inf.					WIDE: 1m - Inf. TELE: 3m - Inf.					WIDE: 0.1m - Inf. TELE: 0.35m - Inf.																
Control	Iris	Motorized					Motorized					Motorized																
	Focus	Motorized					Motorized					Motorized																
	Zoom	Motorized					Motorized					Motorized																
Angle of View	D	1.1"	58.9° - 10.4°	1"	54.1° - 9.5°	2/3"	37.8° - 6.7°	1"	35.9° - 18.3°	2/3"	24.7° - 12.7°	1/1.8"	20.3° - 10.4°	2/3"	50.4° - 16.9°	1/1.8"	42.0° - 14.0°	1/3"	28.4° - 9.5°									
	H																			48.1° - 8.5°	48.1° - 8.5°	30.3° - 5.4°	28.8° - 14.7°	19.8° - 10.2°	16.2° - 8.3°	41.1° - 13.7°	33.9° - 11.3°	22.8° - 7.6°
	V																			35.6° - 6.3°	25.7° - 4.5°	22.8° - 4.0°	21.6° - 11.1°	14.9° - 7.7°	12.2° - 6.3°	31.2° - 10.4°	25.6° - 8.5°	17.1° - 5.7°
Operating Temperature	-20°C - +60°C					-20°C - +60°C					-20°C - +60°C																	

Back Focal Length	WIDE	13.9mm (In Air)					15.0 mm (in Air)					16.4 mm (In Air)				
	TELE	13.9mm (In Air)					16.2 mm (in Air)					15.9 mm (In Air)				
Flange Back Length	17.526mm (In Air)					17.526mm (In Air)					17.526mm (In Air)					
Mount	C-Mount					C-Mount					C-Mount					
Filter Size	M67 P=0.75mm					M52 P=0.75mm					M49 P=0.75mm					
Tripod Screw	1/4-20UNC															
Weight	330g					269g					247g					

Control Interface	USB2.0					USB2.0					USB2.0				
Power mode	Bus power(5V:500mA)					Bus power(5V:500mA)					Bus power(5V:500mA)				
Connector	USB TypeA					USB TypeA					USB TypeA				

- Motorized lenses controllable via the USB interface
- Motorized lenses that can be easily operated from compatible cameras, enabling remote control of zoom, focus, and iris
- High-speed focus control with excellent repeatability
- Ultra-high-resolution varifocal lenses compatible with 1.1-inch 12-megapixel sensors, as well as 1-inch, 2/3-inch, and 1/1.8-inch formats

1.1"	2/3"	MOTORIZED	USB
1"	1/1.8"	VARI	IR

ML3Z1226SC-MPW

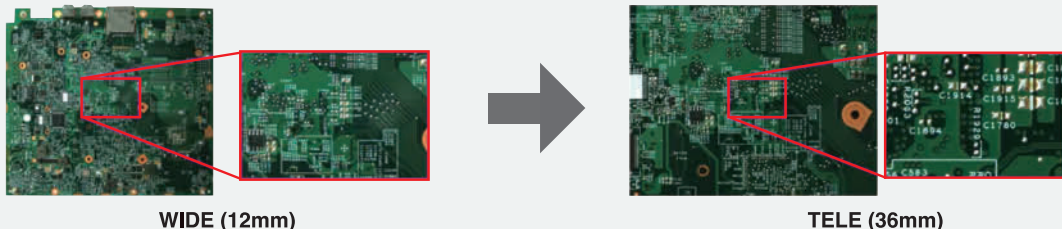

ML2Z0525UC-MPWIR

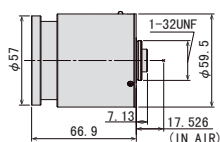

EL3Z0416UCS-MPWIR

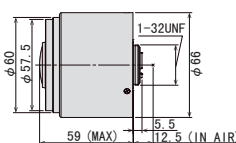

EL6Z0915UCS-MPWIR

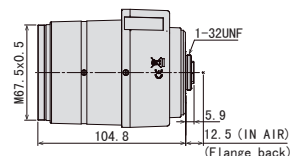

Focal Length	5.5mm - 12.7mm					4.0mm - 10mm					9mm - 50mm				
Max. Image Format	φ 11.8mm					7.1mm × 5.4mm (φ 8.9mm)					7.1mm × 5.4mm (φ 8.9mm)				
Operation Range	Iris: WIDE: F2.5 - F16.0 TELE: F3.7 - F16.0					Iris: WIDE: F1.6 - F16.0 TELE: F2.7 - F16.0					Iris: WIDE: F1.5 - F16.0 TELE: F1.6 - F16.0				
	Focus: 0.1m - Inf.					Focus: 0.2m - Inf.					Focus: 3m - Inf.				
Control	Iris: Motorized					Iris: Motorized					Iris: Motorized				
	Focus: Motorized					Focus: Motorized					Focus: Motorized				
	Zoom: Motorized					Zoom: Motorized					Zoom: Motorized				
Angle of View	D	105.2° - 49.6°	87.8° - 41.0°	59.8° - 27.6°		138.1° - 52.9°	120.3° - 47.5°	86.5° - 35.5°		52.5° - 10.2°	47.4° - 9.2°	35.9° - 7.0°			
	H	86.0° - 40.1°	71.3° - 33.0°	48.1° - 22.2°		104.8° - 42.2°	92.9° - 37.9°	68.1° - 28.4°		42.3° - 8.2°	38.2° - 7.5°	28.8° - 5.7°			
	V	65.6° - 30.3°	54.0° - 24.9°	36.3° - 16.7°		76.3° - 31.6°	68.1° - 28.4°	50.5° - 21.3°		32.4° - 6.3°	28.8° - 5.7°	21.7° - 4.3°			
Operating Temperature	-20°C - +60°C					-20°C - +60°C					-20°C - +60°C				

Back Focal Length	WIDE	11.4mm (In Air)	8.5mm (In Air)	9.2mm (In Air)
	TELE	11.4mm (In Air)	8.5mm (In Air)	9.2mm (In Air)
Flange Back Length	17.526mm (In Air)		12.5mm (In Air)	12.5mm (In Air)
Mount	C-Mount		CS-Mount	CS-Mount
Filter Size	M55 P=0.75mm		M55 P=0.75mm (With VM0418)*	M67 P=0.75mm (With VM0918)*
Tripod Screw				1/4-20UNC
Weight	172g		161g	299g

Control Interface	USB2.0		USB2.0	USB2.0
Power mode	Bus power(5V:500mA)		Bus power(5V:500mA)	Bus power(5V:500mA)
Connector	USB TypeA		USB TypeA	USB TypeA

*When using filters, lens requires VM0418 (sold separately). For more detail please refer to P.50

*When using filters, lens requires VM0918 (sold separately). For more detail please refer to P.50

USB VL-MPZ Series

LensConnect USB VL-MPZ Series



Model No.	Format	Focal Length	F No.	Working Distance	Weight
VL0826U-MPZ	1"	8mm	F2.6	0.1m-Inf.	334g
VL1226U-MPZ		12mm	F2.6	0.1m-Inf.	273g
VL1624U-MPZ		16mm	F2.4	0.1m-Inf.	280g
VL2520U-MPZ		25mm	F2.0	0.15m-Inf.	257g
VL3522U-MPZ		35mm	F2.2	0.2m-Inf.	313g
VL5024U-MPZ		50mm	F2.4	0.2m-Inf.	326g
VL7531U-MPZ		75mm	F3.1	0.25m-Inf.	415g

VL0826U-MPZ

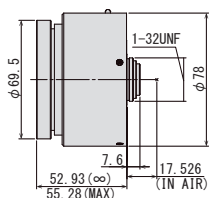

VL1226U-MPZ

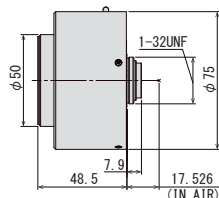

VL1624U-MPZ

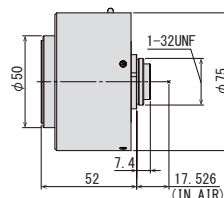

VL2520U-MPZ

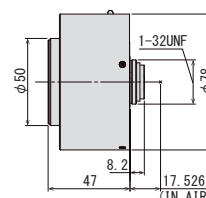

Focal Length	8mm					12mm					16mm					25mm									
Max. Aperture Ratio	1:2.6					1:2.6					1:2.4					1:2.0									
Max. Image Format	12.8mm × 9.6mm (φ 16mm)																								
Operation Range	Iris	F2.6 - F16.0					F2.6 - F16.0					F2.4 - F16.0					F2.0 - F16.0								
	Focus	0.1m - Inf.					0.1m - Inf.					0.1m - Inf.					0.15m - Inf.								
Control	Iris	Motorized					Motorized					Motorized					Motorized								
	Focus	Motorized					Motorized					Motorized					Motorized								
Angle of View	D	88.8°					68.6°					58.2°					47.8°								
	H	1"	76.9°	2/3"	57.1°	1/1.8"	47.8°	1"	67.4°	2/3"	49.8°	1/1.8"	33.7°	1"	53.2°	2/3"	38.1°	1/1.8"	31.6°	1"	35.5°	2/3"	24.9°	1/1.8"	20.5°
	V	61.5°		44.2°		36.6°		44.1°		31.0°		25.5°		33.6°		23.4°		19.2°		21.8°		15.1°		12.4°	
Operating Temperature	-10° C - +50° C					-10° C - +50° C					-10° C - +50° C					-10° C - +50° C									

Optical Distortion	1"	-0.8%	2/3"	-2.1%	1/1.8"	-1.9%	1"	0.0%	2/3"	-1.1%	1/1.8"	-1.0%	1"	0.0%	2/3"	-0.4%	1/1.8"	-0.4%	1"	0.0%	2/3"	0.0%	1/1.8"	0.0%
Back Focal Length	10.6mm (In Air)						10.6mm (In Air)						10.7mm (In Air)						9.1mm (In Air)					
Flange Back Length	17.526mm (In Air)						17.526mm (In Air)						17.526mm (In Air)						17.526mm (In Air)					
Mount	C-Mount																							
Filter Size	M82 P=0.75mm (With ZM0810)*						M46 P=0.75mm						M43 P=0.75mm						M46 P=0.75mm					
Weight	334g					273g					280g					257g								

Control Interface	USB2.0		
Power mode	Bus power(5V:500mA)		
Connector	USB TypeA		

*When using filters, lens requires ZM0810 (sold separately).
For more detail please refer to P.50

- Motorized FA lens that can be operated easily with a single USB cable
- Focus and Iris can be controlled via USB
- Ultra-high resolution lens, suitable for 1" 20 megapixel sensor
- Much lower distortion design for all models is beneficial for a variety of machine vision applications
- Has the newest optical design, which has a much higher relative illuminance compared to conventional models, despite having a large format 1" sensor (Ø16mm)

1"

20MP

MOTORIZED

USB

FIX

FLOATING



VL3522U-MPZ

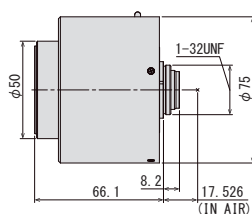

VL5024U-MPZ

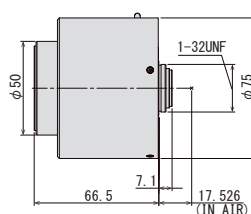

VL7531U-MPZ

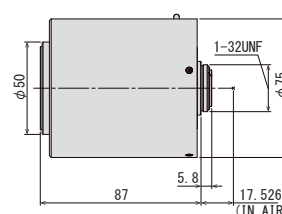

Focal Length	35mm					50mm					75mm								
Max. Aperture Ratio	1:2.2					1:2.4					1:3.1								
Max. Image Format	12.8mm × 9.6mm (φ 16mm)																		
Operation Range	Iris	F2.2 - F16.0					F2.4 - F16.0					F3.1 - F16.0							
	Focus	0.2m - Inf.					0.2m - Inf.					0.25m - Inf.							
Control	Iris	Motorized					Motorized					Motorized							
	Focus	Motorized					Motorized					Motorized							
Angle of View	D	1"	25.8°	2/3"	17.9°	1/1.8"	14.7°	1"	18.2°	2/3"	12.6°	1/1.8"	10.3°	1"	12.2°	2/3"	8.4°	1/1.8"	6.9°
	H		20.8°		14.4°		11.8°		14.6°		10.1°		8.3°		9.8°		6.7°		5.5°
	V		15.7°		10.8°		8.9°		11.0°		7.6°		6.2°		7.3°		5.0°		4.1°
Operating Temperature	-10° C - +50° C					-10° C - +50° C					-10° C - +50° C								

Optical Distortion	1"	0.0%	2/3"	0.0%	1/1.8"	0.0%	1"	0.0%	2/3"	0.0%	1/1.8"	0.0%	1"	0.0%	2/3"	0.0%	1/1.8"	0.0%
Back Focal Length	9.7mm (In Air)					11.1mm (In Air)					12.0mm (In Air)							
Flange Back Length	17.526mm (In Air)					17.526mm (In Air)					17.526mm (In Air)							
Mount	C-Mount																	
Filter Size	M43 P=0.75mm																	
Weight	313g					326g					415g							

Control Interface	USB2.0					USB2.0					USB2.0				
Power mode	Bus power(5V:500mA)					Bus power(5V:500mA)					Bus power(5V:500mA)				
Connector	USB TypeA														

NEW LensConnect

I²C ITS Series

LensConnect I²C ITS Series



- Motorized lenses controllable via the I2C interface
- Motorized lenses that can be easily operated from compatible cameras, enabling remote control of focus and iris
- Focus control through a high-speed and stable interface
- Equipped with ICR switching mechanism inside the lens
- No focus shift from visible light to NIR
- High spectral transmittance between visible light to NIR

1.1" **16MP** **I²C** **IR** **MOTORIZED** **FIX** **FLOATING**

VL2028SM6C-MPYIR

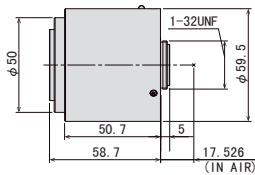

VL2528SM6C-MPYIR

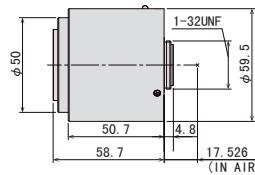

VL3528SM6C-MPYIR

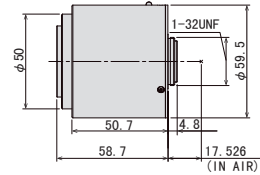

Focal Length	20mm					25mm					35mm								
Max. Image Format	φ 17.6mm					φ 17.6mm					φ 17.6mm								
Operation Range	Iris	F2.8 - F16.0					F2.8 - F16.0					F2.8 - F16.0							
	Focus	0.1m - Inf.					0.12m - Inf.					0.25m - Inf.							
Control	Iris	Motorized					Motorized					Motorized							
	Focus	Motorized					Motorized					Motorized							
Angle of View	D	1.1" (3:1)	47.2°	1.1" (16:9)	45.6°	1" (16:9)	43.8°	1.1" (3:1)	38.5°	1.1" (16:9)	37.1°	1" (16:9)	35.6°	1.1" (3:1)	28.0°	1.1" (16:9)	27.0°	1" (16:9)	25.8°
	H		45.0°		40.2°		39.2°		36.7°		32.6°		31.7°		26.6°		23.6°		22.9°
	V	15.9°	23.5°	21.3°	12.8°	18.9°	17.1°	9.1°	13.6°	12.3°									
Operating Temperature	-20°C - +60°C					-20°C - +60°C					-20°C - +60°C								
Back Focal Length	18.5mm					15.9mm					17.9mm								
Flange Back Length	17.526mm (In Air)					17.526mm (In Air)					17.526mm (In Air)								
Mount	C-Mount					C-Mount					C-Mount								
Filter Size	M35.5 P=0.5mm					M35.5 P=0.5mm					M35.5 P=0.5mm								
Weight	162g					166g					160g								
Control Interface	I ² C					I ² C					I ² C								
Power mode	DC5.0V±10%(500mA max)					DC5.0V±10%(500mA max)					DC5.0V±10%(500mA max)								
Connector	-					-					-								

NEW LensConnect

USBITS Series

LensConnect USB ITS Series

- Motorized lenses controllable via the USB interface
- Motorized lenses that can be easily operated from compatible cameras, enabling remote control of focus and iris
- Focus control through a high-speed and stable interface
- Equipped with ICR switching mechanism inside the lens
- No focus shift from visible light to NIR
- High spectral transmittance between visible light to NIR

1.1" 16MP USB IR MOTORIZED FIX FLOATING



VL2028UM6C-MPYIR

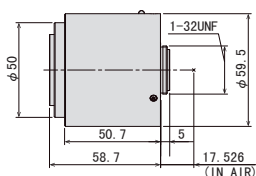

VL2528UM6C-MPYIR

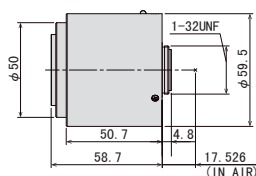

VL3528UM6C-MPYIR

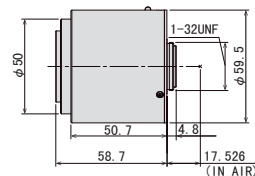

Focal Length	20mm					25mm					35mm							
Max. Image Format	φ 17.6mm					φ 17.6mm					φ 17.6mm							
Operation Range	Iris	F2.8 - F16.0					Iris	F2.8 - F16.0					Iris	F2.8 - F16.0				
	Focus	0.1m - Inf.					Focus	0.12m - Inf.					Focus	0.25m - Inf.				
Control	Iris	Motorized					Iris	Motorized					Iris	Motorized				
	Focus	Motorized					Focus	Motorized					Focus	Motorized				
Angle of View	D	47.2°	1.1" (16:9)	45.6°	1" (16:9)	43.8°	1.1" (3:1)	38.5°	1.1" (16:9)	37.1°	1" (16:9)	35.6°	1.1" (3:1)	28.0°	1.1" (16:9)	27.0°	1" (16:9)	25.8°
	H	45.0°		40.2°		39.2°		36.7°		32.6°		31.7°		26.6°		23.6°		22.9°
	V	15.9°	23.5°	21.3°	12.8°	18.9°	17.1°	9.1°	13.6°	12.3°								
Operating Temperature	-20°C - +60°C					-20°C - +60°C					-20°C - +60°C							
Back Focal Length	18.5mm					15.9mm					17.9mm							
Flange Back Length	17.526mm (In Air)					17.526mm (In Air)					17.526mm (In Air)							
Mount	C-Mount					C-Mount					C-Mount							
Filter Size	M35.5 P=0.5mm					M35.5 P=0.5mm					M35.5 P=0.5mm							
Weight	170g					174g					168g							
Control Interface	USB2.0					USB2.0					USB2.0							
Power mode	Bus power(5V:500mA)					Bus power(5V:500mA)					Bus power(5V:500mA)							
Connector	USB TypeA					USB TypeA					USB TypeA							



MPT Series

1.4" 50 MEGAPIXEL FIXED FOCAL LENS

Model No.	Format	Focal Length	F No.	Working Distance	Weight
F1228-MPT	1.4"	12mm	F2.8	0.15m - Inf.	205g
F1628-MPT		16mm	F2.8	0.15m - Inf.	187g
F2524-MPT		25mm	F2.4	0.15m - Inf.	152g
F3526-MPT		35mm	F2.6	0.15m - Inf.	122g
F5026-MPT		50mm	F2.6	0.25m - Inf.	151g

F1228-MPT

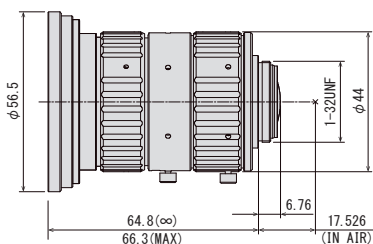

F1628-MPT

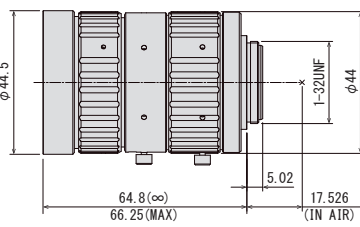

F2524-MPT

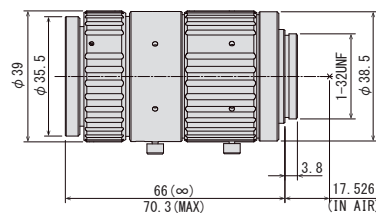

Focal Length		12mm					16mm					25mm							
Max. Aperture Ratio		1:2.8					1:2.8					1:2.4							
Max. Image Format		19.08mm × 13.03mm (φ 23.1mm)					19.08mm × 13.03mm (φ 23.1mm)					19.08mm × 13.03mm (φ 23.1mm)							
Operation Range	Iris	F2.8 - F16.0					F2.8 - F16.0					F2.4 - F16.0							
	Focus	0.15m - Inf.					0.15m - Inf.					0.15m - Inf.							
Control	Iris	Manual					Manual					Manual							
	Focus	Manual					Manual					Manual							
Angle of View	D	1.4"	86.1°	1.2"	76.6°	1.1"	71.6°	1.4"	70.1°	1.2"	61.0°	1.1"	56.5°	1.4"	49.6°	1.2"	42.4°	1.1"	39.0°
	H		76.0°		61.9°		60.4°		60.4°		48.1°		46.9°		41.9°		32.7°		31.8°
	V		56.2°		54.8°		46.1°		43.4°		42.2°		35.2°		29.3°		28.5°		23.6°
Operating Temperature		-10°C - +50°C					-10°C - +50°C					-10°C - +50°C							

Optical Distortion	1.4"	0.13%	1.2"	-0.98%	1.1"	-1.23%	1.4"	0.06%	1.2"	-0.43%	1.1"	-0.54%	1.4"	0.06%	1.2"	-0.34%	1.1"	-0.39%
Back Focal Length	10.8mm						12.7mm						18.1mm					
Flange Back Length	17.526mm						17.526mm						17.526mm					
Mount	C-Mount						C-Mount						C-Mount					
Filter Size	M72 P=0.75mm*						M52 P=0.75mm*						M34 P=0.5mm					
Dimensions	φ56.5mm × 64.8mm						φ44.5mm × 64.8mm						φ39mm × 66mm					
	φ75mm × 66.1mm (with TM-1243)						φ54mm × 66.4mm (with TM-1643)											
Weight	205g						187g						152g					

*When using filters, lens requires TM-1243 (for 12mm) (sold separately). For more detail please refer to P.50

*When using filters, lens requires TM-1643 (for 16mm) (sold separately). For more detail please refer to P.50

- Ultra-high-resolution lens, suitable for 1.4" 50-megapixel sensor
- Enlarged image circle up to Ø23.1mm (1.4" sensor)
- The most compact, lightweight lens design on the machine vision market
- The newest optical design achieves much higher relative illuminance compared to conventional models despite a large format 1.4" sensor (Ø23.1mm)
- Supports vibration and shock resistance up to 5G
- Compatible with the latest image sensor (IMX06A)

1.4"

50MP

MANUAL

FIX

FLOATING

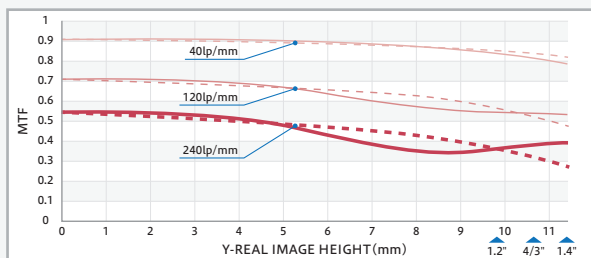

F3526-MPT

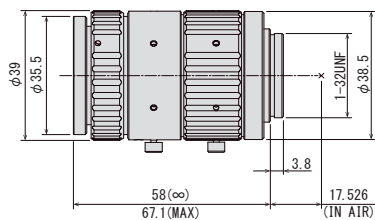

F5026-MPT

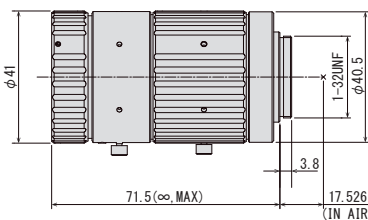

Focal Length	35mm					50mm							
Max. Aperture Ratio	1:2.6					1:2.6							
Max. Image Format	19.08mm × 13.03mm (φ 23.1mm)					19.08mm × 13.03mm (φ 23.1mm)							
Operation Range	Iris	F2.6 - F16.0					F2.6 - F16.0						
	Focus	0.15m - Inf.					0.25m - Inf.						
Control	Iris	Manual					Manual						
	Focus	Manual					Manual						
Angle of View	D	1.4"	36.6°	1.2"	30.9°	1.1"	28.3°	1.4"	26.1°	1.2"	21.9°	1.1"	20.0°
	H	1.4"	30.6°	1.2"	23.6°	1.1"	23.0°	1.4"	21.7°	1.2"	16.7°	1.1"	16.2°
	V	1.4"	21.1°	1.2"	20.5°	1.1"	16.9°	1.4"	14.9°	1.2"	14.4°	1.1"	11.9°
Operating Temperature	-10°C - +50°C					-10°C - +50°C							

Optical Distortion	1.4"	0.01%	1.2"	-0.05%	1.1"	-0.06%	1.4"	-0.02%	1.2"	-0.03%	1.1"	-0.03%
Back Focal Length	23.1mm						14.2mm					
Flange Back Length	17.526mm						17.526mm					
Mount	C-Mount						C-Mount					
Filter Size	M34 P=0.5mm						M30.5 P=0.5mm					
Dimensions	φ39mm × 58mm						φ41mm × 71.5mm					
Weight	122g						151g					



MPY Series

1.1" 24 MEGAPIXEL FIXED FOCAL LENS

Model No.	Format	Focal Length	F No.	Working Distance	Weight
V0828-MPY2	1.1"	8mm	F2.8-F16	0.2m-Inf.	157g
V1228-MPY2		12mm		0.3m-Inf.	97g
V1628-MPY2		16mm		0.3m-Inf.	89g
V2528-MPY		25mm		0.3m-Inf.	78g
V3528-MPY		35mm		0.3m-Inf.	103g
V5028-MPY		50mm		0.5m-Inf.	107g

V0828-MPY2

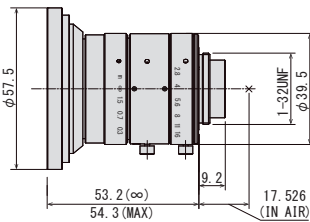

V1228-MPY2

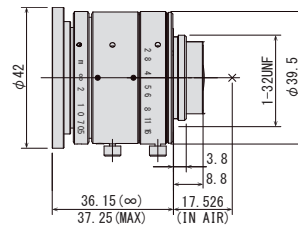

V1628-MPY2

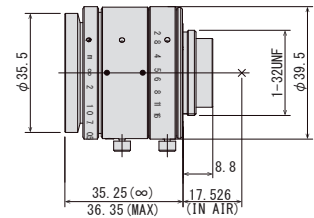

Focal Length		8mm					12mm					16mm							
Max. Aperture Ratio		1:2.8					1:2.8					1:2.8							
Max. Image Format		14.2mm × 10.4mm (φ 17.6mm)					14.2mm × 10.4mm (φ 17.6mm)					14.2mm × 10.4mm (φ 17.6mm)							
Operation Range	Iris	F2.8 - F16.0					F2.8 - F16.0					F2.8 - F16.0							
	Focus	0.2m - Inf.					0.3m - Inf.					0.3m - Inf.							
Control	Iris	Manual					Manual					Manual							
	Focus	Manual					Manual					Manual							
Angle of View	D	1.1"	93.9°	1"	89.3°	2/3"	69.0°	1.1"	71.1°	1"	66.4°	2/3"	48.6°	1.1"	57.9°	1"	53.4°	2/3"	38.2°
	H	1.1"	83.0°	1"	77.3°	2/3"	57.3°	1.1"	60.5°	1"	55.5°	2/3"	39.6°	1.1"	48.2°	1"	43.9°	2/3"	30.9°
	V	1.1"	66.0°	1"	61.7°	2/3"	44.2°	1.1"	46.2°	1"	42.9°	2/3"	30.1°	1.1"	36.2°	1"	33.6°	2/3"	23.4°
Operating Temperature		-10° C - +50° C					-10° C - +50° C					-10° C - +50° C							

Optical Distortion	1.1"	-0.6%	1"	-1.7%	2/3"	-2.8%	1.1"	-0.5%	1"	-1.0%	2/3"	-1.4%	1.1"	-0.5%	1"	-0.6%	2/3"	-0.6%
Back Focal Length	8.6mm						8.4mm						9.4mm					
Flange Back Length	17.526mm						17.526mm						17.526mm					
Mount	C-Mount						C-Mount						C-Mount					
Filter Size	M72 P=0.75mm (with VM0811)* M67 P=0.75mm (with VM0810)*						M40.5 P=0.5mm						M34.0 P=0.5mm					
Dimensions	φ75mm × 53.2mm						φ42.0mm × 36.1mm						φ39.5mm × 35.2mm					
Weight	157g						97g						89g					

*There is no filter mount on the top of the lens.
When using filters, lens requires VM0811 or VM0810 (sold separately).
For more detail, please refer to P50.

- Ultra-high-resolution lens, suitable for 1.1" 24 megapixel sensor
- Enlarged image circle up to $\varnothing 17.6\text{mm}$ (1.1" sensor)
- The most compact, lightweight lens design on the machine vision market
- The floating design achieves an ultra-high-resolution from near focus to infinity
- Supports vibration and shock resistance up to 5G

1.1"

24MP

MANUAL

FIX

FLOATING

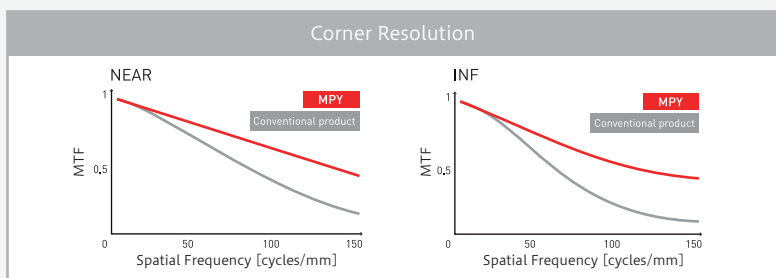

V2528-MPY

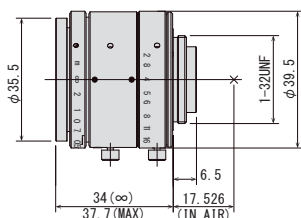

V3528-MPY

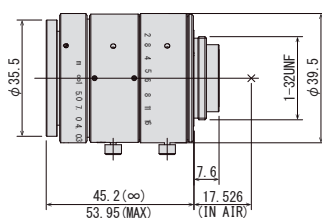

V5028-MPY

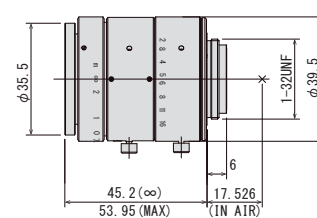

Focal Length	25mm						35mm						50mm						
Max. Aperture Ratio	1:2.8						1:2.8						1:2.8						
Max. Image Format	14.2mm × 10.4mm ($\varnothing 17.6\text{mm}$)						14.2mm × 10.4mm ($\varnothing 17.6\text{mm}$)						14.2mm × 10.4mm ($\varnothing 17.6\text{mm}$)						
Operation Range	Iris	F2.8 - F16.0					F2.8 - F16.0						F2.8 - F16.0						
	Focus	0.3m - Inf.					0.3m - Inf.						0.5m - Inf.						
Control	Iris	Manual					Manual						Manual						
	Focus	Manual					Manual						Manual						
Angle of View	D	1.1"	38.7°	1"	35.4°	2/3"	24.8°	1.1"	28.2°	1"	25.8°	2/3"	17.9°	1.1"	20.0°	1"	18.2°	2/3"	12.6°
	H		31.7°		28.7°		20.0°		22.9°		20.7°		14.3°		16.2°		14.6°		10.1°
	V		23.5°		21.7°		15.0°		16.9°		15.6°		10.8°		11.9°		11.0°		7.6°
Operating Temperature	-10° C - +50° C						-10° C - +50° C						-10° C - +50° C						

Optical Distortion	1.1"	0.3%	1"	0.2%	2/3"	0.1%	1.1"	-0.1%	1"	0.0%	2/3"	0.0%	1.1"	0.1%	1"	0.1%	2/3"	0.1%
Back Focal Length	11.3mm						11.9mm						11.9mm					
Flange Back Length	17.526mm						17.526mm						17.526mm					
Mount	C-Mount						C-Mount						C-Mount					
Filter Size	M34.0 P=0.5mm						M34.0 P=0.5mm						M34.0 P=0.5mm					
Dimensions	$\varnothing 39.5\text{mm} \times 34\text{mm}$						$\varnothing 39.5\text{mm} \times 45.2\text{mm}$						$\varnothing 39.5\text{mm} \times 45.2\text{mm}$					
Weight	78g						103g						107g					

MPZ Series

1" 20 MEGA PIXEL FIXED FOCAL LENS



Model No.	Format	Focal Length	F No.	Working Distance	Weight
V0826-MPZ	1"	8mm	F2.6-F16	0.1m-Inf.	203g
V1226-MPZ		12mm	F2.6-F16	0.1m-Inf.	98g
V1624-MPZ		16mm	F2.4-F16	0.1m-Inf.	108g
V2520-MPZ		25mm	F2.0-F16	0.15m-Inf.	73g
V3522-MPZ		35mm	F2.2-F16	0.2m-Inf.	118g
V5024-MPZ		50mm	F2.4-F16	0.2m-Inf.	138g
V7531-MPZ		75mm	F3.1-F16	0.25m-Inf.	176g

V0826-MPZ

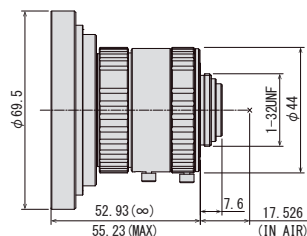

V1226-MPZ

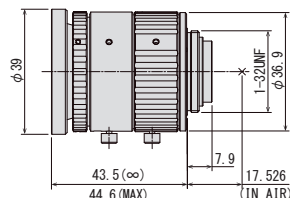

V1624-MPZ

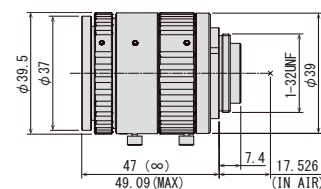

Focal Length	8mm					12mm					16mm								
Max. Aperture Ratio	1:2.6					1:2.6					1:2.4								
Max. Image Format	12.8mm × 9.6mm (φ 16mm)					12.8mm × 9.6mm (φ 16mm)					12.8mm × 9.6mm (φ 16mm)								
Operation Range	Iris	F2.6 - F16.0					F2.6 - F16.0					F2.4 - F16.0							
	Focus	0.1m - Inf.					0.1m - Inf.					0.1m - Inf.							
Control	Iris	Manual					Manual					Manual							
	Focus	Manual					Manual					Manual							
Angle of View	D	1"	88.8°	2/3"	68.6°	1/1.8"	58.2°	1"	67.4°	2/3"	49.8°	1/1.8"	41.5°	1"	53.2°	2/3"	38.1°	1/1.8"	31.6°
	H	1"	76.9°	2/3"	57.1°	1/1.8"	47.8°	1"	56.7°	2/3"	40.7°	1/1.8"	33.7°	1"	43.8°	2/3"	30.9°	1/1.8"	25.5°
	V	1"	61.5°	2/3"	44.2°	1/1.8"	36.6°	1"	44.1°	2/3"	31.0°	1/1.8"	25.5°	1"	33.6°	2/3"	23.4°	1/1.8"	19.2°
Operating Temperature	-10° C - +50° C					-10° C - +50° C					-10° C - +50° C								
Optical Distortion	1"	-0.8%	2/3"	-2.1%	1/1.8"	-1.9%	1"	0.0%	2/3"	-1.1%	1/1.8"	-1.0%	1"	0.0%	2/3"	-0.4%	1/1.8"	-0.4%	
Back Focal Length	10.6mm					10.6mm					10.7mm								
Flange Back Length	17.526mm					17.526mm					17.526mm								
Mount	C-Mount					C-Mount					C-Mount								
Filter Size	M82 P=0.75mm (with ZM0810)*					M37.5 P=0.5mm					M35.5 P=0.5mm								
Dimensions	φ 69.5mm × 52.93mm					φ 39mm × 43.5mm					φ 39.5mm × 47mm								
	φ 85.0mm × 53.83mm (with ZM0810)																		
Weight	203g					98g					108g								

*There is no filter mount on the top of the lens.
When using filters, lens requires ZM0810 (sold separately).
For more detail, please refer to P.34.

- Ultra-high resolution lens, which is suitable for 1" 20 megapixel sensor
- Much lower distortion design for all models is beneficial for a variety of machine vision applications
- Has the newest optical design, which has a much higher relative illuminance compared to conventional models, despite having a large format 1" sensor
- Supports vibration and shock resistance up to 5G

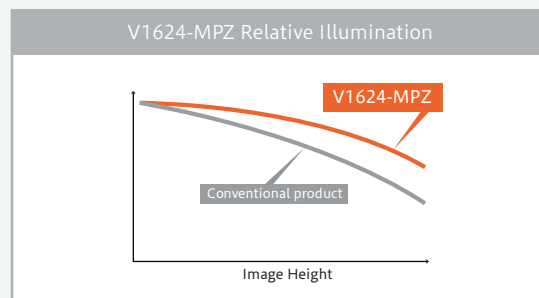
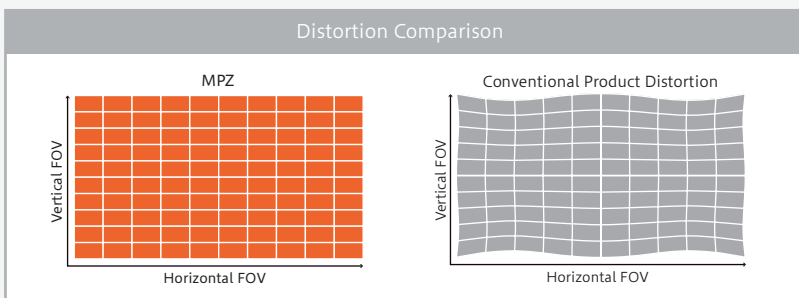

	V2520-MPZ	V3522-MPZ	V5024-MPZ	V7531-MPZ

Focal Length	25mm					35mm					50mm					75mm									
Max. Aperture Ratio	1:2.0					1:2.2					1:2.4					1:3.1									
Max. Image Format	12.8mm × 9.6mm (φ 16mm)					12.8mm × 9.6mm (φ 16mm)					12.8mm × 9.6mm (φ 16mm)					12.8mm × 9.6mm (φ 16mm)									
Operation Range	Iris F2.0 - F16.0					F2.2 - F16.0					F2.4 - F16.0					F3.1 - F16.0									
	Focus 0.15m - Inf.					0.2m - Inf.					0.2m - Inf.					0.25m - Inf.									
Control	Iris Manual					Manual					Manual					Manual									
	Focus Manual					Manual					Manual					Manual									
Angle of View	D	35.5°		24.9°		20.5°		25.8°		17.9°		14.7°		18.2°		12.6°		10.3°		12.2°		8.4°		6.9°	
	H	1" 28.8°		2/3" 20.0°		1/1.8" 16.4°		1" 20.8°		2/3" 14.4°		1/1.8" 11.8°		1" 14.6°		2/3" 10.1°		1/1.8" 8.3°		1" 9.8°		2/3" 6.7°		1/1.8" 5.5°	
	V	21.8°		15.1°		12.4°		15.7°		10.8°		8.9°		11.0°		7.6°		6.2°		7.3°		5.0°		4.1°	
Operating Temperature	-10° C - +50° C					-10° C - +50° C					-10° C - +50° C					-10° C - +50° C									

Optical Distortion	1" 0.0%	2/3" 0.0%	1/1.8" 0.0%	1" 0.0%	2/3" 0.0%	1/1.8" 0.0%	1" 0.0%	2/3" 0.0%	1/1.8" 0.0%	1" 0.0%	2/3" 0.0%	1/1.8" 0.0%	1" 0.0%	2/3" 0.0%	1/1.8" 0.0%
Back Focal Length	9.1mm			9.7mm			11.1mm			12.0mm					
Flange Back Length	17.526mm			17.526mm			17.526mm			17.526mm					
Mount	C-Mount			C-Mount			C-Mount			C-Mount					
Filter Size	M35.5 P=0.5mm			M34 P=0.5mm			M30.5 P=0.5mm			M30.5 P=0.5mm					
Dimensions	φ 37.5mm × 35.7mm			φ 39.5mm × 55.7mm			φ 42mm × 60.1mm			φ 42.0mm × 79.8mm					
Weight	73g			118g			138g			176g					



MPX Series

2/3" 16MEGAPIXEL FIXED FOCAL LENS

Model No.	Format	Focal Length	F No.	Working Distance	Weight
M0528-MPX	2/3"	5.5mm	F2.8-F16	0.1m - Inf	116g
M0828-MPX		8mm			89g
M1228-MPX		12mm			78g
M1628-MPX		16mm			74g
M2528-MPX		25mm		83g	
M3528-MPX		35mm		82g	
M5028-MPX		50mm		85g	
M7538-MPX		75mm	F3.8 - F16	0.25m - Inf	89g

NEW M0528-MPX

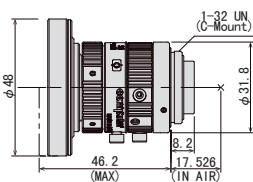

M0828-MPX

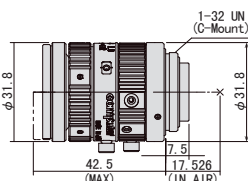

M1228-MPX

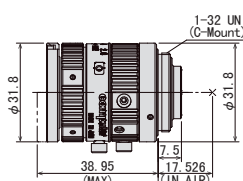

M1628-MPX

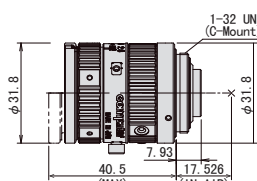

Focal Length	5.5mm					8mm					12mm					16mm									
Max. Aperture Ratio	1:2.8					1:2.8					1:2.8					1:2.8									
Max. Image Format	φ 11.8mm					φ 11.8mm					φ 11.8mm					φ 11.8mm									
Operation Range	Iris	F2.8 - F16.0					Iris	F2.8 - F16.0					Iris	F2.8 - F16.0					Iris	F2.8 - F16.0					
	Focus	0.1m - Inf					Focus	0.1m - Inf					Focus	0.1m - Inf					Focus	0.1m - Inf					
Control	Iris	Manual					Iris	Manual					Iris	Manual					Iris	Manual					
	Focus	Manual					Focus	Manual					Focus	Manual					Focus	Manual					
Angle of View	D		90.4°		73.8°		58.6°		67.5°		52.0°		40.2°		49.2°		36.9°		28.1°		37.9°		28.1°		21.3°
	H	2/3"	78.9°	1/2"	61.8°	1/3"	48.1°	2/3"	56.4°	1/2"	42.6°	1/3"	32.6°	2/3"	40.3°	1/2"	29.9°	1/3"	22.7°	2/3"	30.8°	1/2"	22.7°	1/3"	17.1°
	V		63.4°		48.1°		36.8°		43.9°		32.6°		24.7°		30.8°		22.7°		17.1°		23.4°		17.1°		12.9°
Operating Temperature	-10°C - +50°C					-10°C - +50°C					-10°C - +50°C					-10°C - +50°C									

Optical Distortion	2/3"	-0.10%	1/2"	-2.47%	1/3"	-2.12%	2/3型	0.06%	1/2"	-0.39%	1/3"	-0.38%	2/3"	0.13%	1/2"	-0.03%	1/3"	-0.05%	2/3"	0.24%	1/2"	0.00%	1/3"	-0.03%
Back Focal Length	9.4mm						10.2mm						10.2mm						10.3mm					
Flange Back Length	17.526mm						17.526mm						17.526mm						17.526mm					
Mount	C-Mount						C-Mount						C-Mount						C-Mount					
Filter Size	M58 P=0.75mm						M40.5 P=0.5mm						M30.5 P=0.5mm						M30.5 P=0.5mm					
Dimensions	φ 48.0mm × 43.2mm						φ 31.8mm × 39.45mm						φ 31.8mm × 35.9mm						φ 31.8mm × 39.5mm					
Weight	116g						89g						78g						74g					

*When using filters, lens requires XM0523 (sold separately). For more detail please refer to P.50

*When using filters, lens requires XM0823 (sold separately). For more detail please refer to P.50

- Anti-vibration(10G) and shock resistance design(10G) to adapt to harsh inspection environments
- High-resolution lens 2μm or less pixel size supported
- Floating mechanism enables high performance from close-up to long distance
- Precise focus adjustment with a focus rotation angle 3 times greater than usual lenses
- Adoption of click-type iris mechanism
- Wide lineup of f=5.5mm/8mm/12mm/16mm/25mm/35mm/50mm/75mm

2/3"

16MP

MANUAL

FIX

FLOATING

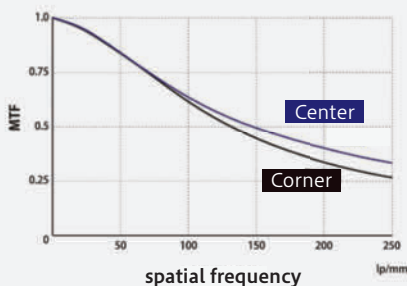

Existing Lens
Focus ring rotation angle: 200°



3x wider rotation angle!

Easy focus adjustment



MPX
Focus ring rotation angle: 610°



M2528-MPX

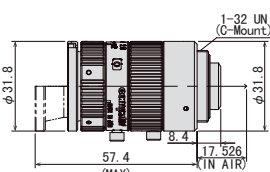

M3528-MPX

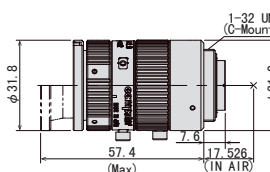

M5028-MPX

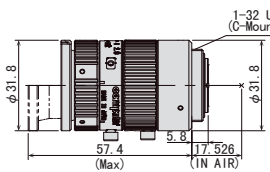

M7538-MPX

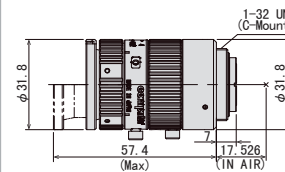

Focal Length	25mm					35mm					50mm					75mm												
Max. Aperture Ratio	1:2.8					1:2.8					1:2.8					1:3.8												
Max. Image Format	φ 11.8mm					φ 11.8mm					φ 11.8mm					φ 11.8mm												
Operation Range	Iris	F2.8 - F16.0				Iris	F2.8 - F16.0				Iris	F2.8 - F16.0				Iris	F3.8 - F16.0											
	Focus	0.1m - Inf				Focus	0.15m - Inf				Focus	0.2m - Inf				Focus	0.25m - Inf											
Control	Iris	Manual				Iris	Manual				Iris	Manual				Iris	Manual											
	Focus	Manual				Focus	Manual				Focus	Manual				Focus	Manual											
Angle of View	D	24.8°	18.2°	13.7°		17.8°	13.0°	9.8°		12.6°	9.1°	6.9°		8.6°	6.3°	4.7°												
	H	2/3"	20.0°	1/2"	14.6°	1/3"	11.0°		2/3"	14.3°	1/2"	10.4°	1/3"	7.8°		2/3"	10.1°	1/2"	7.3°	1/3"	5.5°		2/3"	6.9°	1/2"	5.0°	1/3"	3.8°
	V		15.1°		11.0°		8.3°		10.8°		7.8°		5.9°		7.5°		5.5°		4.1°		5.2°		3.8°		2.8°			
Operating Temperature	-10°C - +50°C					-10°C - +50°C					-10°C - +50°C					-10°C - +50°C												

Optical Distortion	2/3"	0.06%	1/2"	0.00%	1/3"	-0.01%	2/3"	0.10%	1/2"	0.10%	1/3"	0.06%	2/3"	0.04%	1/2"	0.07%	1/3"	0.05%	2/3"	0.00%	1/2"	0.14%	1/3"	0.11%
Back Focal Length	9.5mm						10.9mm						13.2mm						11.9mm					
Flange Back Length	17.526mm						17.526mm						17.526mm						17.526mm					
Mount	C-Mount						C-Mount						C-Mount						C-Mount					
Filter Size	M30.5 P=0.5mm						M30.5 P=0.5mm						M30.5 P=0.5mm						M30.5 P=0.5mm					
Dimensions	φ 31.8mm × 46mm						φ 31.8mm × 46mm						φ 31.8mm × 46mm						φ 31.8mm × 46mm					
Weight	83g						82g						85g						89g					



MPW3 Series

2/3" 6 MEGAPIXEL FIXED FOCAL LENS

Model No.	Format	Focal Length	F No.	Working Distance	Weight
M0528-MPW3	2/3"	5mm	F2.8-F16	0.1m-Inf.	163g
M0828-MPW3		8mm		0.1m-Inf.	58g
M1228-MPW3		12mm		0.1m-Inf.	60g
M1628-MPW3		16mm		0.25m-Inf.	37g
M2528-MPW3		25mm		0.2m-Inf.	42g
M3528-MPW3		35mm		0.25m-Inf.	48g
M5028-MPW3		50mm		0.3m-Inf.	65g
M7528-MPW3		75mm		0.4m-Inf.	102g

M0528-MPW3

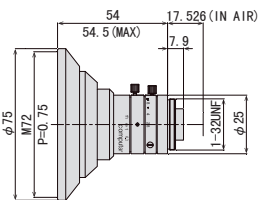

M0828-MPW3

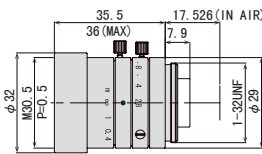

M1228-MPW3

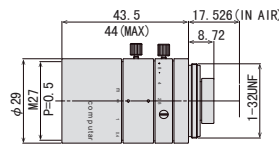

M1628-MPW3

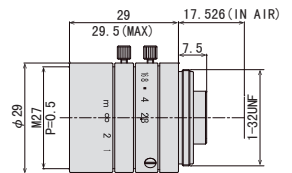

Focal Length	5mm					8mm					12mm					16mm									
Max. Aperture Ratio	1:2.8					1:2.8					1:2.8					1:2.8									
Max. Image Format	8.8mm × 6.6mm (φ 11mm)					8.8mm × 6.6mm (φ 11mm)					8.8mm × 6.6mm (φ 11mm)					8.8mm × 6.6mm (φ 11mm)									
Operation Range	Iris	F2.8 - F16.0					Iris	F2.8 - F16.0					Iris	F2.8 - F16.0					Iris	F2.8 - F16.0					
	Focus	0.1m - Inf.					Focus	0.1m - Inf.					Focus	0.1m - Inf.					Focus	0.25m - Inf.					
Control	Iris	Manual					Iris	Manual					Iris	Manual					Iris	Manual					
	Focus	Manual					Focus	Manual					Focus	Manual					Focus	Manual					
Angle of View	D		94.6°		83.8°		71.4°		68.5°		57.7°		47.2°		49.3°		40.8°		33.0°		37.8°		31.4°		25.0°
	H	2/3"	83.2°	1/1.8"	71.6°	1/2.5"	59.8°	2/3"	57.0°	1/1.8"	47.3°	1/2.5"	38.5°	2/3"	40.3°	1/1.8"	33.1°	1/2.5"	26.7°	2/3"	30.7°	1/1.8"	25.3°	1/2.5"	20.2°
	V		67.5°		58.3°		46.6°		44.2°		37.5°		29.4°		30.8°		26.0°		20.3°		23.3°		19.2°		15.3°
Operating Temperature	-10° C - +50° C					-10° C - +50° C					-10° C - +50° C					-10° C - +50° C									

Optical Distortion	2/3"	0.03%	1/1.8"	-2.14%	1/2.5"	-2.72%	2/3"	-1.80%	1/1.8"	-1.68%	1/2.5"	-1.28%	2/3"	-0.10%	1/1.8"	0.04%	1/2.5"	0.00%	2/3"	0.47%	1/1.8"	0.15%	1/2.5"	0.03%
Back Focal Length	9.2mm						10.1mm						9.2mm						10.3mm					
Flange Back Length	17.526mm						17.526mm						17.526mm						17.526mm					
Mount	C-Mount						C-Mount						C-Mount						C-Mount					
Filter Size	M72 P=0.75mm						M30.5 P=0.5mm						M27 P=0.5mm						M27 P=0.5mm					
Dimensions	φ 75mm × 54mm						φ 32mm × 35.5mm						φ 29mm × 43.5mm						φ 29mm × 29mm					
Weight	163g						58g						60g						37g					

- Suitable for 2/3" 6 megapixel
- A variety of focal lengths from 5mm to 75mm
- Maintains high performance at long WD
- Has an ultra-compact Ø29 diameter with a nearly-identical mechanical length
- High resolution up to the edges of the screen
- Vibration resistance up to 5G

2/3"

6MP

MANUAL

FIX

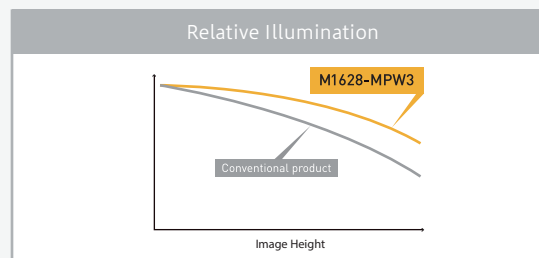
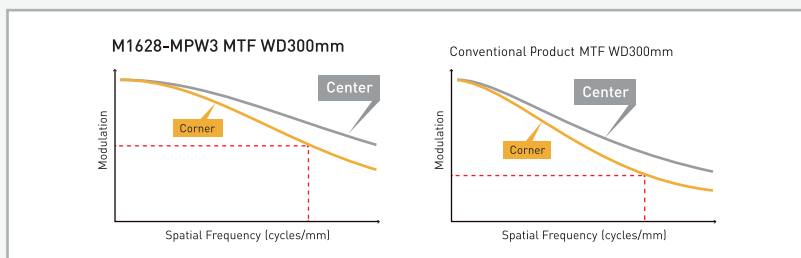

	M2528-MPW3	M3528-MPW3	M5028-MPW3	M7528-MPW3

Focal Length	25mm					35mm					50mm					75mm				
Max. Aperture Ratio	1:2.8																			
Max. Image Format	8.8mm × 6.6mm (φ 11mm)																			
Operation Range	Iris F2.8 - F16.0																			
	Focus 0.2m - Inf.																			
Control	Iris Manual																			
	Focus Manual																			
Angle of View	D	24.6°	20.3°	16.1°	17.9°	14.4°	11.6°	12.5°	10.2°	8.1°	8.4°	6.9°	5.4°							
	H	2/3" 19.9°	1/1.8" 16.3°	1/2.5" 13.0°	2/3" 14.3°	1/1.8" 11.7°	1/2.5" 9.3°	2/3" 10.0°	1/1.8" 8.2°	1/2.5" 6.5°	2/3" 6.7°	1/1.8" 5.5°	1/2.5" 4.3°							
	V	15.0°	12.3°	9.8°	10.8°	8.7°	7.0°	7.5°	6.2°	4.9°	5.0°	4.1°	3.3°							
Operating Temperature	-10° C - +50° C					-10° C - +50° C					-10° C - +50° C					-10° C - +50° C				

Optical Distortion	2/3"	0.77%	1/1.8"	0.49%	1/2.5"	0.29%	2/3"	0.06%	1/1.8"	0.04%	1/2.5"	0.03%	2/3"	0.00%	1/1.8"	0.00%	1/2.5"	0.00%	2/3"	0.33%	1/1.8"	0.21%	1/2.5"	0.12%
Back Focal Length	11.5mm						18.0mm						26.3mm						14.6mm					
Flange Back Length	17.526mm						17.526mm						17.526mm						17.526mm					
Mount	C-Mount																							
Filter Size	M27 P=0.5mm						M27 P=0.5mm						M27 P=0.5mm						M34 P=0.5mm					
Dimensions	φ 29mm × 31.5mm						φ 29mm × 38.5mm						φ 29mm × 56mm						φ 36mm × 75mm					
Weight	42g						48g						65g						102g					



MP2 Series

2/3" 1.5 MEGA PIXEL FIXED FOCAL LENS

Model No.	Format	Focal Length	F No.	Working Distance	Weight
H0514-MP2	2/3"	5mm	F1.4 - F16C	0.1m - Inf.	102g
M0814-MP2		8mm	F1.4 - F16C	0.1m - Inf.	63g
M1214-MP2		12mm	F1.4 - F16C	0.15m - Inf.	62g
M1614-MP2		16mm	F1.4 - F16C	0.3m - Inf.	60g
M2514-MP2		25mm	F1.4 - F16C	0.3m - Inf.	71g
M3514-MP		35mm	F1.4 - F16C	0.3m - Inf.	87g
M5018-MP2		50mm	F1.8 - F16C	0.5m - Inf.	85g
M7528-MP	75mm	F2.8 - F16C	0.3m - Inf.	113g	

H0514-MP2

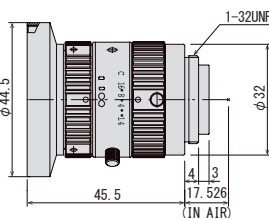

M0814-MP2

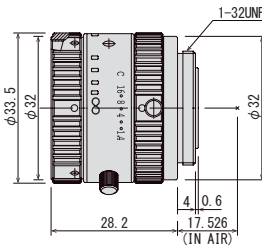

M1214-MP2

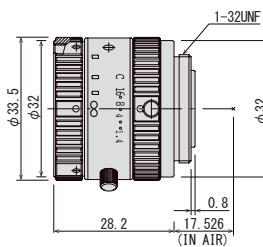

M1614-MP2

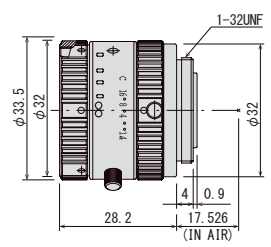

Focal Length	5mm				8mm				12mm				16mm				
Max. Aperture Ratio	1:1.4				1:1.4				1:1.4				1:1.4				
Max. Image Format	6.4mm × 4.8mm (φ 8mm)				8.8mm × 6.6mm (φ 11mm)				8.8mm × 6.6mm (φ 11mm)				8.8mm × 6.6mm (φ 11mm)				
Operation Range	Iris	F1.4 - F16C			Iris	F1.4 - F16C			Iris	F1.4 - F16C			Iris	F1.4 - F16C			
	Focus	0.1m - Inf.			Focus	0.1m - Inf.			Focus	0.15m - Inf.			Focus	0.3m - Inf.			
Control	Iris	Manual			Iris	Manual			Iris	Manual			Iris	Manual			
	Focus	Manual			Focus	Manual			Focus	Manual			Focus	Manual			
Angle of View	D	76.7°		62.3°		67.1°		51.9°		49.2°		37.0°		38.0°		28.2°	
	H	1/2" 65.5°		1/3" 51.4°		2/3" 56.3°		1/2" 42.5°		2/3" 40.4°		1/2" 30.0°		2/3" 30.8°		1/2" 22.7°	
	V	51.4°		39.5°		43.7°		32.4°		30.8°		22.7°		23.4°		17.1°	
Operating Temperature	-10° C - +50° C				-10° C - +50° C				-10° C - +50° C				-10° C - +50° C				

Optical Distortion	1/2"	-0.48%	1/3"	-2.26%	2/3"	-0.1%	1/2"	-1.1%	2/3"	-0.1%	1/2"	-0.35%	2/3"	-0.1%	1/2"	-0.3%
Back Focal Length	10.8mm				13.1mm				13.1mm				13.1mm			
Flange Back Length	17.526mm				17.526mm				17.526mm				17.526mm			
Mount	C-Mount				C-Mount				C-Mount				C-Mount			
Filter Size	M43 P=0.75mm				M30.5 P=0.5mm				M30.5 P=0.5mm				M30.5 P=0.5mm			
Dimensions	φ 44.5mm × 45.5mm				φ33.5mm × 28.2mm				φ33.5mm × 28.2mm				φ33.5mm × 28.2mm			
Weight	102g				63g				62g				60g			

- Eight focal lengths in series: 5mm, 8mm, 12mm, 16mm, 25mm, 35mm, 50mm, and 75mm
- Compatible with 2/3" format sensor (H0514-MP2 : 1/2")
- Low distortion (less than 1.0%)
- Locking set screws for focus and iris
- Compact design - diameter 33.5mm (H0514-MP2 : 44.5mm)

1/2"	1.5MP	MANUAL
2/3"		FIX

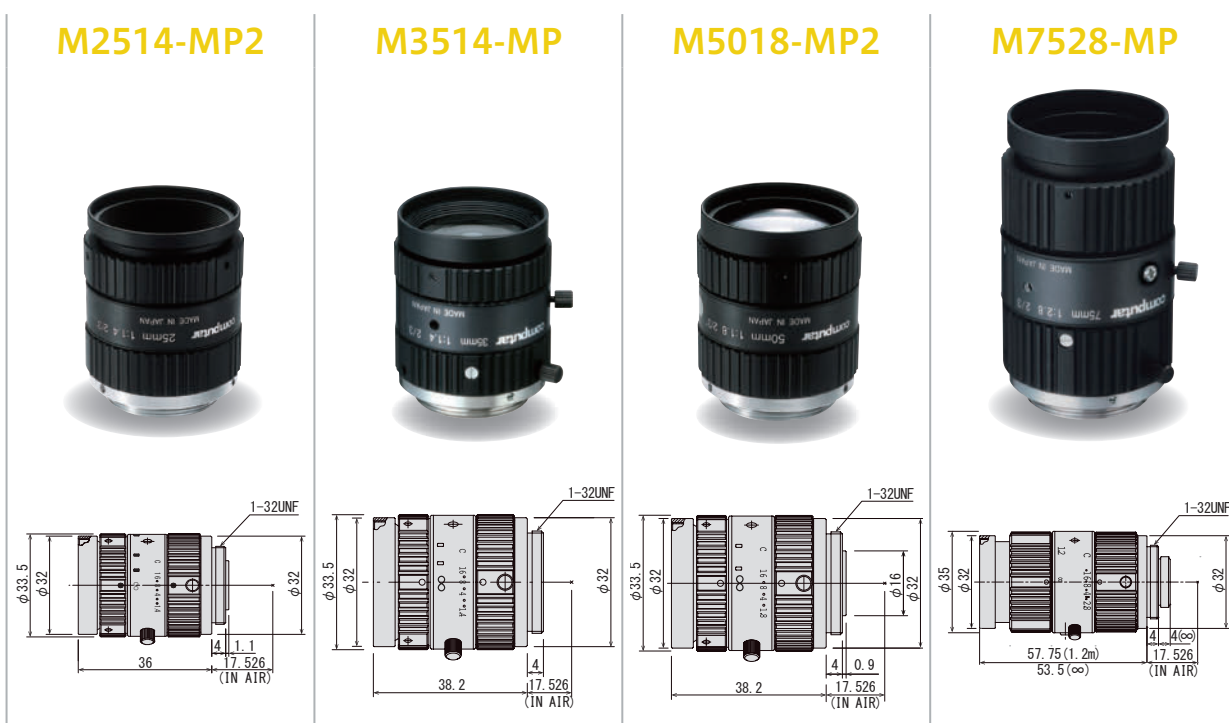

Focal Length	25mm				35mm				50mm				75mm				
Max. Aperture Ratio	1:1.4				1:1.4				1:1.8				1:2.8				
Max. Image Format	8.8mm × 6.6mm (φ 11mm)				8.8mm × 6.6mm (φ 11mm)				8.8mm × 6.6mm (φ 11mm)				8.8mm × 6.6mm (φ 11mm)				
Operation Range	Iris	F1.4 - F16C			F1.4 - F16C			F1.8 - F16C			F2.8 - F16C						
	Focus	0.3m - Inf.			0.3m - Inf.			0.5m - Inf.			0.3m - Inf. (※)						
Control	Iris	Manual			Manual			Manual			Manual						
	Focus	Manual			Manual			Manual			Manual						
Angle of View	D	24.9°		18.2°		17.3°		12.6°		13.1°		9.5°		8.5°		6.2°	
	H	2/3" 20.0°		1/2" 14.6°		2/3" 13.9°		1/2" 10.1°		2/3" 10.5°		1/2" 7.6°		2/3" 6.8°		1/2" 5.0°	
	V	15.1°		11.0°		10.4°		7.6°		7.9°		5.7°		5.1°		3.7°	
Operating Temperature	-10° C - +50° C				-10° C - +50° C				-10° C - +50° C				-10° C - +50° C				

Optical Distortion	2/3"	-0.3%	1/2"	-0.1%	2/3"	-0.8%	1/2"	-0.4%	2/3"	-0.3%	1/2"	-0.2%	2/3"	-0.4%	1/2"	-0.2%
Back Focal Length	13.1mm				17.1mm				13.1mm				21.5mm			
Flange Back Length	17.526mm				17.526mm				17.526mm				17.526mm			
Mount	C-Mount				C-Mount				C-Mount				C-Mount			
Filter Size	M30.5 P=0.5mm				M30.5 P=0.5mm				M30.5 P=0.5mm				M30.5 P=0.5mm			
Dimensions	φ33.5mm × 36.0mm				φ 33.5mm × 38.2mm				φ 33.5mm × 38.2mm				φ 35mm × 57.7mm			
Weight	71g				87g				85g				113g			

*Factory setting is 0.3-1.2m. Focus can be adjusted to infinity by removing "Focus Limit Screw"

VISIBLE + SWIR IMAGE SENSOR FIXED FOCAL LENS



VISIBLE + SWIR IMAGE SENSOR FIXED FOCAL LENS

- Dedicated design for next generation Visible+SWIR InGaAs image sensor (IMX992/IMX993)
- Hyper-Apochromat design with fully correct focus shift between 400-1700nm
- Floating-focus mechanism realizes axial chromatic aberration and chromatic aberration of magnification at all WD and wavelengths
- High transmittance at entire wavelength of 400nm-1700nm by adopting hyper wideband AR coat
- The NIR-absorbent coating prevents light scattering and provides clear image quality

Model No.	Format	Focal Length	F-No.	Working Distance	Weight
M0818-APVSW2	1/1.4" (2/3")	8mm	F1.8	0.1m - Inf.	171g
M1218-APVSW3		12mm		0.1m - Inf.	159g
M1618-APVSW2		16mm		0.1m - Inf.	170g
M2518-APVSW2		25mm		0.1m - Inf.	140g
M3518-APVSW		35mm		0.15m - Inf.	199g
M5018-APVSW		50mm		0.2m - Inf.	174g

M0818-APVSW2

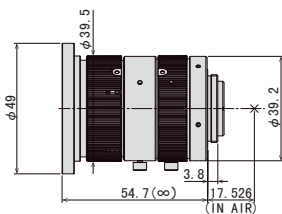

M1218-APVSW3

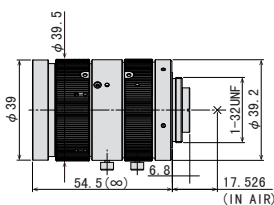

M1618-APVSW2

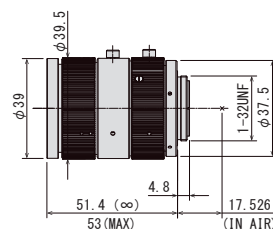

Focal Length	8mm							12mm							16mm										
Max. Aperture Ratio	1:1.8							1:1.8							1:1.8										
Max. Image Format	φ 11.4mm							φ 11.4mm							φ 11.4mm										
Wavelength Range	400nm - 1700nm							400nm - 1700nm							400nm - 1700nm										
Operation Range	Iris F1.8 - F16.0							F1.8 - F16.0							F1.8 - F16.0										
	Focus 0.1m - Inf.							0.1m - Inf.							0.1m - Inf.										
Control	Iris Manual							Manual							Manual										
	Focus Manual							Manual							Manual										
Angle of View	D	68.7°		56.6°		53.2°		28.1°		50.5°		40.4°		37.9°		19.5°		38.9°		31.0°		28.8°		14.6°	
	H	1/1.4"	56.6°	1/1.8"	46.7°	1/2"	42.7°	1/4"	22.1°	1/1.4"	40.5°	1/1.8"	32.9°	1/2"	30.0°	1/4"	15.2°	1/1.4"	31.0°	1/1.8"	25.0°	1/2"	22.7°	1/4"	11.4°
	V	46.7°		35.8°		34.7°		17.7°		32.9°		25.0°		24.2°		12.2°		25.0°		18.9°		18.2°		9.2°	
Operating Temperature	-10° C - +50° C							-10° C - +50° C							-10° C - +50° C										

Optical Distortion	1/1.4"	0.6%	1/1.8"	-0.3%	1/1.4"	-0.02%	1/1.8"	-0.3%	1/1.4"	0.1%	1/1.8"	-0.3%
Back Focal Length	11.5mm				12.0mm				14.2mm			
Flange Back Length	17.526mm				17.526mm				17.526mm			
Mount	C-Mount				C-Mount				C-Mount			
Filter Size	M46 P=0.75mm				M37.5 P=0.5mm				M37.5 P=0.5mm			
Dimensions	φ 49mm×54.7mm				φ 39.5mm×54.5mm				φ 39.5mm×51.4mm			
Weight	171g				159g				170g			

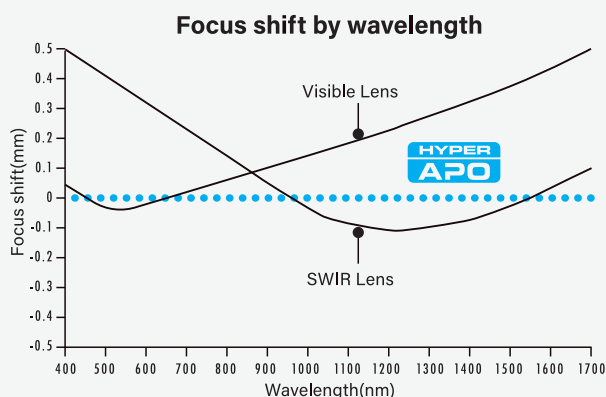

Ultra-high resolution from 400 nm visible light to 1700 nm near infrared with no focus shift.

1/1.4"
(2/3")

5MP

Visible
+
SWIR

MANUAL

Apochromat

FIX

FLOATING



M2518-APVSW2

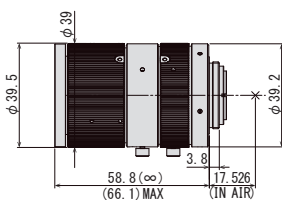

M3518-APVSW

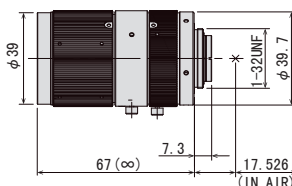

M5018-APVSW

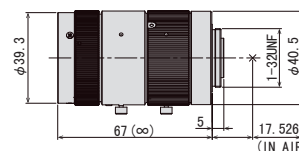

Focal Length	25mm				35mm				50mm				
Max. Aperture Ratio	1:1.8				1:1.8				1:1.8				
Max. Image Format	φ 11.4mm				φ 11.4mm				φ 11.4mm				
Wavelength Range	400nm - 1700nm				400nm - 1700nm				400nm - 1700nm				
Operation Range	Iris	F1.8 - F16.0				F1.8 - F16.0				F1.8 - F16.0			
	Focus	0.1m - Inf.				0.15m - Inf.				0.2m - Inf.			
Control	Iris	Manual				Manual				Manual			
	Focus	Manual				Manual				Manual			
Angle of View	D	25.5°	20.0°	18.6°	9.4°	18.4°	14.4°	13.4°	6.8°	12.8°	10.1°	9.5°	4.7°
	H	1/1.4" 20.0°	1/1.8" 16.1°	1/2" 14.6°	1/4" 7.3°	1/1.4" 14.4°	1/1.8" 11.6°	1/2" 10.5°	1/4" 5.3°	1/1.4" 10.2°	1/1.8" 8.1°	1/2" 7.4°	1/4" 3.7°
	V	16.1°	12.1°	11.7°	5.9°	11.6°	8.7°	8.4°	4.2°	8.2°	6.1°	5.9°	3.0°
Operating Temperature	-10° C - +50° C				-10° C - +50° C				-10° C - +50° C				

Optical Distortion	1/1.4"	0.0%	1/1.8"	-0.1%	1/1.4"	0.0%	1/1.8"	0.0%	1/1.4"	0.2%	1/1.8"	0.2%
Back Focal Length	11.9mm				12.6mm				13.4mm			
Flange Back Length	17.526mm				17.526mm				17.526mm			
Mount	C-Mount				C-Mount				C-Mount			
Filter Size	M37.5 P=0.5mm				M37.5 P=0.5mm				M37.5 P=0.5mm			
Dimensions	φ39.5mm×58.8mm				φ41mm×67.0mm				φ41mm×67.0mm			
Weight	140g				199g				174g			



VISIR Lite

VISIBLE + SWIR IMAGE SENSOR FIXED FOCAL LENS

Model No.	Format	Focal Length	F-No.	Working Distance	Distortion	Weight
H0514-VSW	1/2"	5mm	F1.4	0.1m - Inf.	-0.48%(y=4.0)	102g
M0814-VSW	2/3"	8mm		0.1m - Inf.	-0.1%(y=5.5)	63g
M1214-VSW		12mm		0.15m - Inf.	-0.1%(y=5.5)	62g
M1614-VSW		16mm		0.3m - Inf.	-0.1%(y=5.5)	60g
M2514-VSW		25mm		0.3m - Inf.	-0.3%(y=5.5)	71g
M3514-VSW		35mm		0.3m - Inf.	-0.8%(y=5.5)	87g
M5018-VSW		50mm	F1.8	0.5m - Inf.	-0.3%(y=5.5)	85g

H0514-VSW

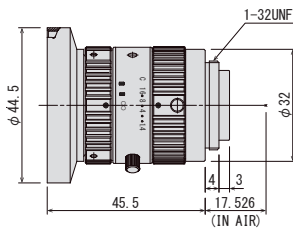

M0814-VSW

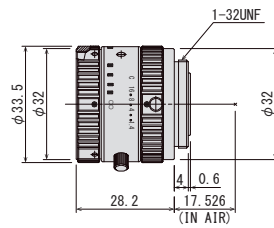

M1214-VSW

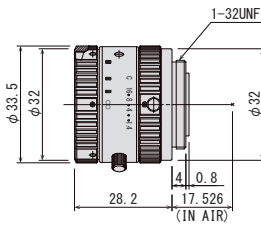

M1614-VSW

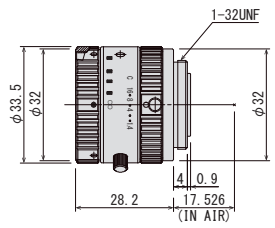

Focal Length	5mm					8mm					12mm					16mm						
Max. Aperture Ratio	1:1.4					1:1.4					1:1.4					1:1.4						
Max. Image Format	6.40mm × 5.12mm (φ 8.20mm)					8.8mm × 6.6mm (φ 11mm)					8.8mm × 6.6mm (φ 11mm)					8.8mm × 6.6mm (φ 11mm)						
Wavelength Range	400nm - 1700nm					400nm - 1700nm					400nm - 1700nm					400nm - 1700nm						
Operation Range	Iris	F1.4 - 16C					F1.4 - F16C					F1.4 - F16C					F1.4 - F16C					
	Focus	0.1m - Inf.					0.1m - Inf.					0.15m - Inf.					0.3m - Inf.					
Control	Iris	Manual					Manual					Manual					Manual					
	Focus	Manual					Manual					Manual					Manual					
Angle of View	D	IMX990	77.8°	IMX991	44.6°	76.7°	IMX990	53.0°	IMX991	27.9°	67.1°	IMX990	37.8°	IMX991	19.4°	49.2°	IMX990	28.8°	IMX991	14.6°	38.0°	
	H	6.40mm	65.5°	3.20mm	35.3°	1/2"	65.5°	6.40mm	42.5°	3.20mm	21.9°	2/3"	56.3°	6.40mm	30.0°	40.4°	6.40mm	22.7°	3.20mm	11.4°	2/3"	30.8°
	V	5.12mm	54.5°	2.56mm	28.5°	51.4°	5.12mm	34.5°	2.56mm	17.6°	43.7°	5.12mm	24.1°	2.56mm	12.2°	30.8°	5.12mm	18.2°	2.56mm	9.2°	23.4°	
Operating Temperature	-10°C - +50°C					-10°C - +50°C					-10°C - +50°C					-10°C - +50°C						

Optical Distortion	1/2"	-0.48%	1/3"	-2.26%	2/3"	-0.1%	1/2"	-1.1%	2/3"	-0.1%	1/2"	-0.35%	2/3"	-0.1%	1/2"	-0.3%
Back Focal Length	10.8mm				13.1mm				13.1mm				13.1mm			
Flange Back Length	17.526mm				17.526mm				17.526mm				17.526mm			
Mount	C-Mount				C-Mount				C-Mount				C-Mount			
Filter Size	M43 P=0.75mm				M30.5 P=0.5mm				M30.5 P=0.5mm				M30.5 P=0.5mm			
Dimensions	φ44.5mm × 45.5mm				φ33.5mm × 28.2mm				φ33.5mm × 28.2mm				φ33.5mm × 28.2mm			
Weight	102g				63g				62g				60g			

- High transmittance at entire wavelength of 400nm-1700nm by adopting hyper wideband AR coat
- Outstanding cost-performance for single-wavelength lighting and narrow-band imaging
- Series includes 5mm, 8mm, 12mm, 16mm, 25mm, 35mm, and 50mm focal lengths
- The SWIR-absorbent coating prevents light scattering and provides clear image quality
- Compact design

1/2"

Visible
+SWIR

MANUAL

2/3"

Visible
+SWIR

FIX

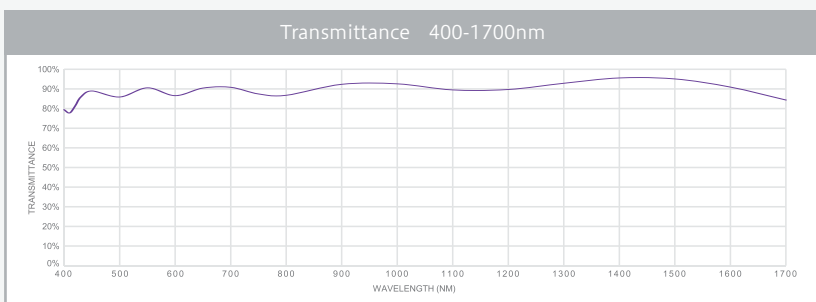

M2514-VSW

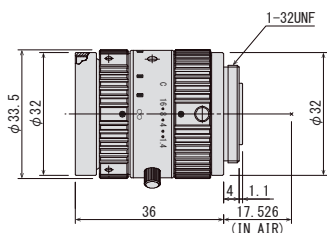

M3514-VSW

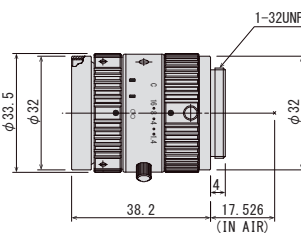

M5018-VSW

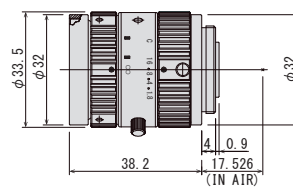

Focal Length	25mm					35mm					50mm								
Max. Aperture Ratio	1:1.4					1:1.4					1:1.8								
Max. Image Format	8.8mm × 6.6mm (φ 11mm)					8.8mm × 6.6mm (φ 11mm)					8.8mm × 6.6mm (φ 11mm)								
Wavelength Range	400nm - 1700nm					400nm - 1700nm					400nm - 1700nm								
Operation Range	Iris	F1.4 - F16C				F1.4 - F16C					F1.8 - F16C								
	Focus	0.3m - Inf.				0.3m - Inf.					0.5m - Inf.								
Control	Iris	Manual				Manual					Manual								
	Focus	Manual				Manual					Manual								
Angle of View	D	IMX990	18.6°	IMX991	9.4°	2/3"	24.9°	IMX990	13.7°	IMX991	6.9°	2/3"	17.3°	IMX990	9.8°	IMX991	4.9°	2/3"	13.1°
	H	6.40mm × 14.6°	3.20mm × 7.3°	20.0°	6.40mm × 10.7°		3.20mm × 5.4°	13.9°	6.40mm × 7.6°	3.20mm × 3.8°	10.5°								
	V	5.12mm × 11.7°	2.56mm × 5.9°	15.1°	5.12mm × 8.6°		2.56mm × 4.3°	10.4°	5.12mm × 6.1°	2.56mm × 3.1°	7.9°								
Operating Temperature	-10° C - +50° C					-10° C - +50° C					-10° C - +50° C								

Optical Distortion	2/3"	-0.3%	1/2"	-0.1%	2/3"	-0.8%	1/2"	-0.39%	2/3"	-0.3%	1/2"	-0.2%
Back Focal Length	13.1mm				17.1mm				13.1mm			
Flange Back Length	17.526mm				17.526mm				17.526mm			
Mount	C-Mount				C-Mount				C-Mount			
Filter Size	M30.5 P=0.5mm				M30.5 P=0.5mm				M30.5 P=0.5mm			
Dimensions	φ33.5mm × 36mm				φ33.5mm × 38.2mm				φ33.5mm × 38.2mm			
Weight	71g				87g				85g			

NEW

I²C LensConnect
VISWIR

VISIBLE+SWIR IMAGE SENSOR LensConnect I²C Series

- Compatible with IMX992 / IMX993 / IMX990 / IMX991
- High transmittance from 400 nm to 1700 nm
- Field of view (FOV) can be adjusted depending on the application
- Optional: A filter switcher can be added inside the lens

Visible +SWIR 1/1.4" 5MP I²C
VARI MOTORIZED



ML2Z0525SC-VSW

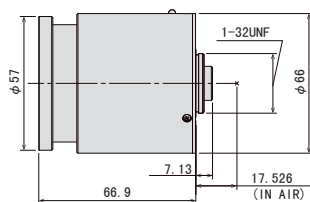

ML3Z1226SC-VSW

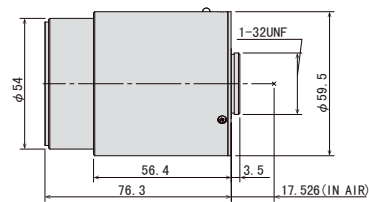

Focal Length	5.5mm - 12.5mm				12mm - 35mm				
Max. Image Format	φ11.4mm				φ11.4mm				
Operation Range	Iris	F2.5 - F16C				F2.6 - F16C			
	Focus	0.1m-Inf				WIDE:0.1m - Inf TELE:0.35m - Inf			
Control	Iris	Motorized				Motorized			
	Focus	Motorized				Motorized			
	Zoom	Motorized				Motorized			
Angle of View	D	107.6°~50.9°	86.0°~40.1°	80.6°~37.5°	41.2°~19.0°	51.7°~18.0°	41.1°~14.3°	38.5°~13.3°	19.5°~6.8°
	H	1/1.4" 86.3°~40.2°	1/1.8" 70.0°~32.4°	1/2" 63.7°~29.4°	1/4" 32.3°~14.8°	1/1.4" 41.3°~14.3°	1/1.8" 33.4°~11.6°	1/2" 30.3°~10.5°	1/4" 15.3°~5.3°
	V	70.0°~32.4°	53.0°~24.5°	51.3°~23.6°	25.9°~11.9°	33.4°~11.6°	25.2°~8.7°	24.3°~8.4°	12.3°~4.3°
Operating Temperature	-20° C - +60° C				-20° C - +60° C				

Back Focal Length	WIDE	11.4mm (In Air)	16.4mm (In Air)
	TELE	11.4mm (In Air)	15.9mm (In Air)
Flange Back Length	17.526mm (In Air)		17.526mm (In Air)
Mount	C-Mount		
Filter Size	M55 P=0.75mm		M49 P=0.75mm
Weight	164g		239g

Control Interface	I ² C	I ² C
Power mode	DC5.0V ± 10% (500mA max)	DC5.0V ± 10% (500mA max)
Connector	-	-

NEW

USB LensConnect VISWIR

VISIBLE+SWIR IMAGE SENSOR LensConnect USB Series

- Compatible with IMX992 / IMX993 / IMX990 / IMX991
- High transmittance from 400 nm to 1700 nm
- Field of view (FOV) can be adjusted depending on the application
- Optional: A filter switcher can be added inside the lens

Visible +SWIR 1/1.4" 5MP USB
 VARI MOTORIZED



ML2Z0525UC-VSW

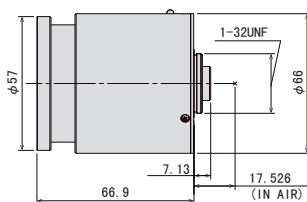

ML3Z1226UC-VSW

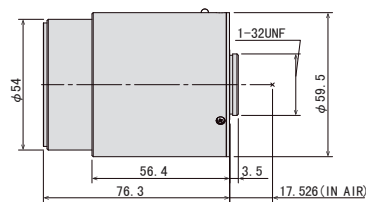

Focal Length	5.5mm - 12.5mm								12mm - 35mm								
Max. Image Format	φ11.4mm								φ11.4mm								
Operation Range	Iris	F2.5 - F16C								F2.6 - F16C							
	Focus	0.1m-Inf								WIDE:0.1m - Inf TELE:0.35m - Inf							
Control	Iris	Motorized								Motorized							
	Focus	Motorized								Motorized							
	Zoom	Motorized								Motorized							
Angle of View	D		107.6°~50.9°		86.0°~40.1°		80.6°~37.5°	1/4"	41.2°~19.0°		51.7°~18.0°		41.1°~14.3°		38.5°~13.3°		19.5°~6.8°
	H	1/1.4"	86.3°~40.2°	1/1.8"	70.0°~32.4°	1/2"	63.7°~29.4°	1/4"	32.3°~14.8°	1/1.4"	41.3°~14.3°	1/1.8"	33.4°~11.6°	1/2"	30.3°~10.5°	1/4"	15.3°~5.3°
	V		70.0°~32.4°		53.0°~24.5°		51.3°~23.6°		25.9°~11.9°		33.4°~11.6°		25.2°~8.7°		24.3°~8.4°		12.3°~4.3°
Operating Temperature	-20° C - +60° C								-20° C - +60° C								

Back Focal Length	WIDE	11.4mm (In Air)								16.4mm (In Air)							
	TELE	11.4mm (In Air)								15.9mm (In Air)							
Flange Back Length	17.526mm (In Air)								17.526mm (In Air)								
Mount	C-Mount								C-Mount								
Filter Size	M55 P=0.75mm								M49 P=0.75mm								
Weight	172g								247g								

Control Interface	USB2.0								USB2.0							
Power mode	Bus power (5V:500mA)								Bus power (5V:500mA)							
Connector	USB TypeA								USB Type A							



MACRO ZOOM LENS

- 1/2" and 2/3" format models are ideal for a variety of inspection applications
- Optimal performance at variable working distances
- Highly versatile 3.3x magnification type suitable for megapixel applications
- Compact design

1/2" 1MP MANUAL
2/3" ZOOM MACRO

MLM-3XMP

2/3"

1MP

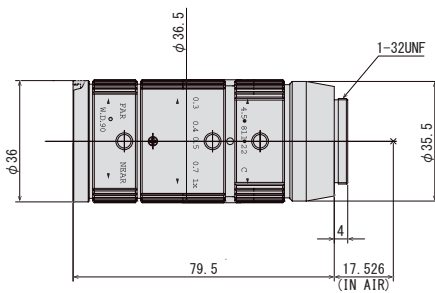

MLH-10X

1/2"

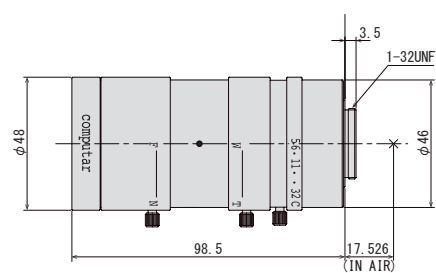

Optical Magnification	0.3x - 1.0x				0.084x - 0.84x							
Max. Aperture Ratio	1:4.5				1:5.6							
Max. Image Format	8.8mm × 6.6mm (φ 11mm)				6.4mm × 4.8mm (φ 8mm)							
Operation Range	Iris	F4.5 - F22C			F5.6 - F32C							
	Focus	90mm			150mm - 450mm							
Control	Iris	Manual			Manual							
	Focus	Manual			Manual							
	Zoom	Manual			Manual							
Angle of View	D		14.9° - 2.9°	1/2"		10.7° - 2.8°	1/2"		17.0° - 3.3°	1/4"		13.0° - 2.5°
	H	2/3"	11.8° - 2.8°		8.5° - 2.2°	1/2"		21.6° - 4.5°	1/3"		13.8° - 2.7°	10.6° - 2.0°
	V		8.8° - 2.3°		6.4° - 1.7°	1/2"		18.0° - 3.6°	1/3"		10.6° - 2.0°	8.0° - 1.5°
Operating Temperature	-10° C - +50° C				-10° C - +50° C							
Optical Distortion	2/3"	+0.12% at 0.3x +1.78% at 1.0x	1/2"	+0.12% at 0.3x +0.77% at 1.0x	1/2"	+0.9% at 0.084x +1.6% at 0.84x						
Back Focal Length	20.4mm				23.29mm							
Flange Back Length	17.526mm				17.526mm							
Mount	C-Mount				C-Mount							
Filter Size	M34 P=0.5mm				M46 P=0.75mm							
Dimensions	φ36.5mm × 79.5mm				φ48mm × 98.5mm							
Weight	150g				260g							

TELECENTRIC MACRO LENS



- WD140mm~Infinity. Suitable for use as a telephoto lens and macro lens [TEC-M55]
- Compact design, compatible with 5MP sensors [TEC-M55MPW]
- 1.1" format 5MP, 7.1X magnification (0.07X-0.5X) [TEC-V7X]

1.1"	5MP	MANUAL	MACRO
2/3"		ZOOM	TELECENTRIC

TEC-M55

2/3"

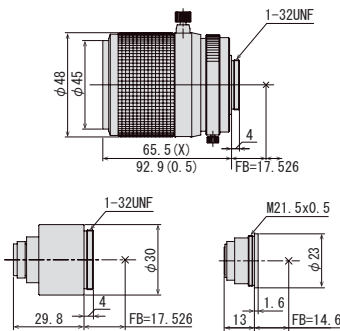

TEC-M55MPW

2/3"

5MP

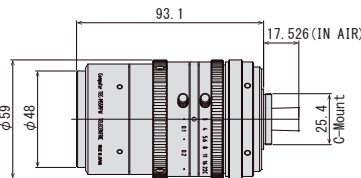

TEC-V7X

1.1"

5MP

ZOOM

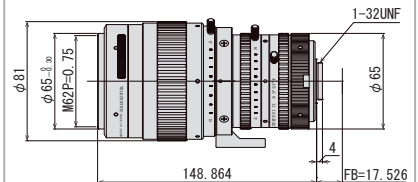

Magnification	0.5x - Inf. (Max 1.0x at 140mm with 2X Converter)		0.057x - 0.5x		0.07x - 0.5x		
Max. Aperture Ratio	1:2.8		1:3.0		1:4.3		
Max. Image Format	8.8mm × 6.6mm (φ 11mm)		8.8mm × 6.6mm (φ 11mm)		12.3mm × 12.3mm (φ 17.4mm)		
Operation Range	Iris	F2.8 - F32C		F3.0 - F22C		F4.3 - F32	
	Focus	140mm - Inf.		139mm - 1000mm		182mm - 577.2mm	
Control	Iris	Manual		Manual		Manual	
	Focus	Manual		Manual		Manual	
	Zoom					Manual	
Operating Temperature	-20° C - +50° C		-10° C - +50° C		-10° C - +50° C		

Optical Distortion	2/3"	+0.2% at 0.2x	1/2"	+0.1% at 0.2x	2/3"	+0.52% at 0.057x	Tele 1.1"	1.0%	1"	0.84%	2/3"	0.39%
		+0.6% at 0.5x		+0.3% at 0.5x		+0.6% at 0.5x		-1.7%		-1.45%		-0.7%
Back Focal Length	29.8mm			17.0mm			Tele	39.53mm				
							Wide	49.78mm				
Flange Back Length	17.526mm			17.526mm			17.526mm					
Mount	C-Mount			C-Mount			C-Mount					
Filter Size	M43 P=0.75mm			M46.0 P=0.75mm			M62 P=0.75mm					
Dimensions	φ53.0mm × 92.9mm (Max. at 0.5x)			φ 59.0mm × 93.1mm			φ 61 × 152.86mm					
Weight	320g			400g			1400g					

TEC-V Series

1.1", 1" MEGAPIXEL TELECENTRIC LENS



- 1.1" format 12MP (3.45μm) [TEC-V0345165MPY-WI]
- 1" format 5MP
- Versatile lineup designed for WD65mm and 110mm [TEC-V05/10]

1.1"	12MP
1"	5MP TELECEN

1.1" 12 MEGAPIXEL TELECENTRIC LENS

TEC-V0345165MPY-WI

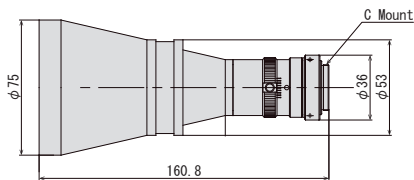

Model	TEC-V0345165MPY-WI
Format	14.2mm × 10.4mm (φ 17.6mm)
Magnification	0.345x
Working Distance	165.2mm
Resolving Power *1	9.7μm
Depth of Field *2	6.63mm
NA	0.0345
Effective F-number	5-32.4
TV Distortion	-0.024%

Mount	C-mount
Filter Size	M72 P=0.75mm
Weight	380g

1" 5 MEGAPIXEL TELECENTRIC LENS

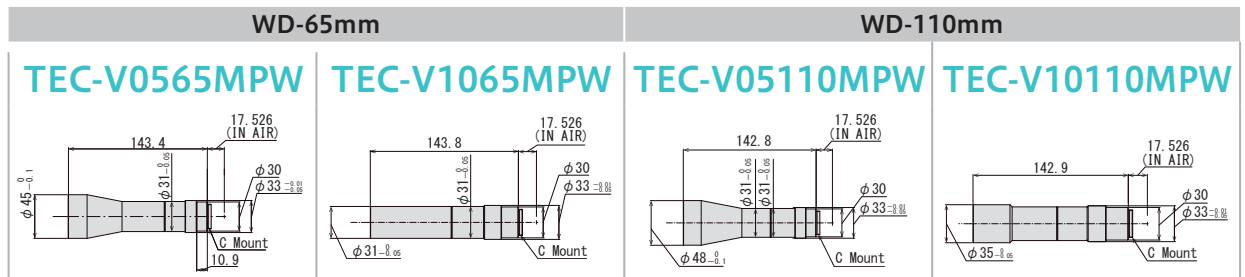

	WD-65mm	WD-65mm	WD-110mm	WD-110mm
	TEC-V0565MPW	TEC-V1065MPW	TEC-V05110MPW	TEC-V10110MPW
Model	TEC-V0565MPW	TEC-V1065MPW	TEC-V05110MPW	TEC-V10110MPW
Format	12.8mm × 9.6mm (φ 16.0mm)	12.8mm × 9.6mm (φ 16.0mm)	12.8mm × 9.6mm (φ 16.0mm)	12.8mm × 9.6mm (φ 16.0mm)
Magnification	0.5x	1.0x	0.5x	1.0x
Working Distance	65.2mm	65.2mm	110.2mm	110.2mm
Resolving Power *1	12μm	6μm	12μm	6μm
Depth of Field *2	2.88mm	0.72mm	2.88mm	0.72mm
NA	0.027	0.055	0.027	0.055
Effective F-number	9.0	9.0	9.0	9.0
TV Distortion	-0.014%	-0.023%	0.012%	0.015%

Mount	C-Mount	C-Mount	C-Mount	C-Mount
Weight	189g	158g	197g	159g

*1 : Theoretical resolution calculated with a wavelength of 550nm *2 : Value calculated with a permissible circle of confusion of 40μm
 *Variable Iris type available (TEC-V05110MPW WI/TEC-V10110MPW WI)

TEC-M Series

2/3" 2 MEGAPIXEL TELECENTRIC LENS

- Suitable for 2/3" 2MP sensor, WD65mm WD110mm

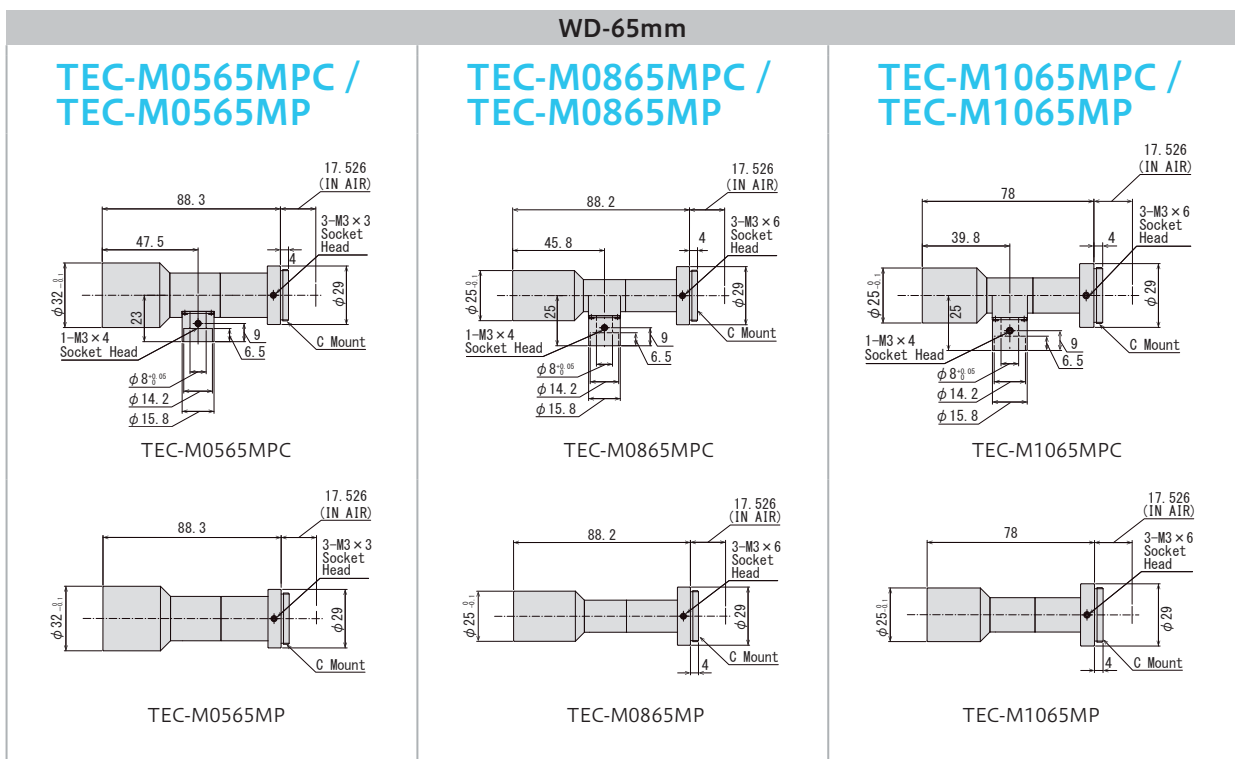

Model (with coaxial type)	TEC-M0565MPC	TEC-M0865MPC	TEC-M1065MPC
Model (straight type)	TEC-M0565MP	TEC-M0865MP	TEC-M1065MP
Format	8.8mm × 6.6mm (φ 11.0mm)	8.8mm × 6.6mm (φ 11.0mm)	8.8mm × 6.6mm (φ 11.0mm)
Magnification	0.5x	0.8x	1.0x
Working Distance	65.5mm	66mm	65.5mm
Resolving Power *1	12μm	8μm	6.7μm
Depth of Field *2	2.87mm	1.18mm	0.79mm
NA	0.028	0.042	0.05
Effective F-number	9.0	9.4	9.8
TV Distortion	-0.012%	0.008%	-0.022%

Mount	C-Mount	C-Mount	C-Mount
Weight (with coaxial type)	80g	62g	54g
Weight (straight type)	77g	57g	49g

*1 : Theoretical resolution calculated with a wavelength of 550nm *2 : Value calculated with a permissible circle of confusion of 40μm

2/3" 2 MEGAPIXEL TELECENTRIC LENS

- Suitable for 2/3" 2MP sensor, WD65mm WD110mm

WD-65mm

TEC-M2065MPC / TEC-M2065MP

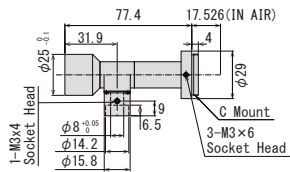

TEC-M2065MPC

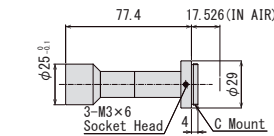

TEC-M2065MP

TEC-M4065MPC / TEC-M4065MP

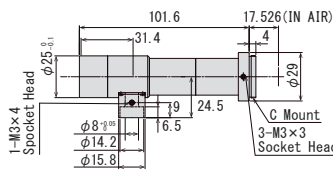

TEC-M4065MPC

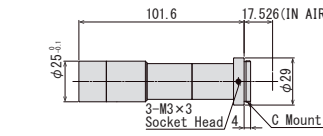

TEC-M4065MP

TEC-M6065MPC / TEC-M6065MP

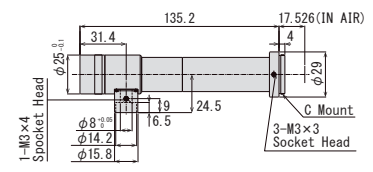

TEC-M6065MPC

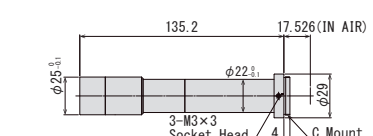

TEC-M6065MP

Model (with coaxial type)	TEC-M2065MPC	TEC-M4065MPC	TEC-M6065MPC
Model (straight type)	TEC-M2065MP	TEC-M4065MP	TEC-M6065MP
Format	8.8mm × 6.6m (φ 11.0mm)	2/3" φ 12.8mm	2/3" φ 12.8mm
Magnification	2.0x	4.0x	6.0x
Working Distance	65.4mm	65.3mm	64.0mm
Resolving Power *1	4.4μm	2.9μm	2.9μm
Depth of Field *2	0.26mm	0.08mm	0.06mm
NA	0.076	0.118	0.118
Effective F-number	12.8	16.9	25.5
TV Distortion	0.020%	-0.003%	-0.026%

Mount	C-Mount	C-Mount	C-Mount
Weight (with coaxial type)	55g	85g	100g
Weight (straight type)	49g	83g	98g

WD-110mm

TEC-M03110MPC / TEC-M03110MP

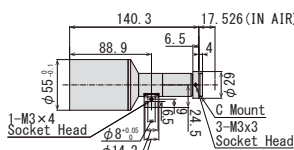

TEC-M03110MPC

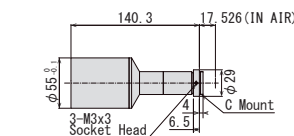

TEC-M03110MP

TEC-M05110MPC / TEC-M05110MP

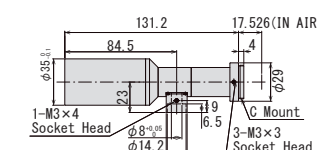

TEC-M05110MPC

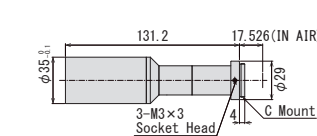

TEC-M05110MP

TEC-M08110MPC / TEC-M08110MP

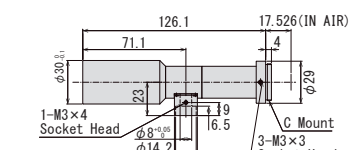

TEC-M08110MPC

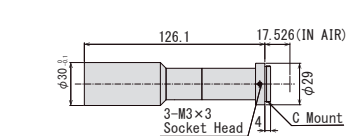

TEC-M08110MP

Model (with coaxial type)	TEC-M03110MPC	TEC-M05110MPC	TEC-M08110MPC
Model (straight type)	TEC-M03110MP	TEC-M05110MP	TEC-M08110MP
Format	8.8mm × 6.6m (φ 11.0mm)	8.8mm × 6.6m (φ 11.0mm)	8.8mm × 6.6m (φ 11.0mm)
Magnification	0.3x	0.5x	0.8x
Working Distance	111mm	111.8mm	111mm
Resolving Power *1	14.5μm	12.7μm	8.8μm
Depth of Field *2	5.75mm	3.03mm	1.31mm
NA	0.023	0.026	0.038
Effective F-number	6.5	9.4	10.2
TV Distortion	0.026%	-0.009%	-0.027%

Mount	C-Mount	C-Mount	C-Mount
Weight (with coaxial type)	166g	131g	106g
Weight (straight type)	160g	128g	103g

*1 : Theoretical resolution calculated with a wavelength of 550nm *2 : Value calculated with a permissible circle of confusion of 40μm

2/3"

2MP

TELECCN

WD-110mm

TEC-M10110MPC / TEC-M10110MP

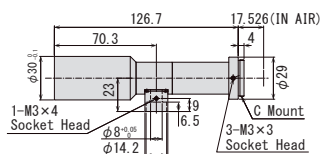

TEC-M10110MPC

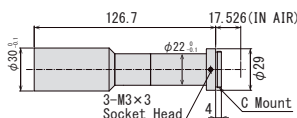

TEC-M10110MP

TEC-M15110MPC / TEC-M15110MP

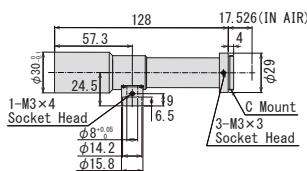

TEC-M15110MPC

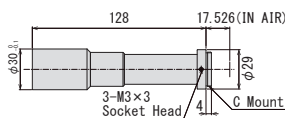

TEC-M15110MP

TEC-M20110MPC / TEC-M20110MP

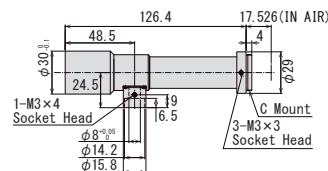

TEC-M20110MPC

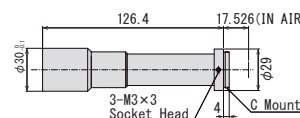

TEC-M20110MP

Model (with coaxial type)	TEC-M10110MPC	TEC-M15110MPC	TEC-M20110MPC
Model (straight type)	TEC-M10110MP	TEC-M15110MP	TEC-M20110MP
Format	8.8mm × 6.6mm (φ 11.0mm)	8.8mm × 6.6mm (φ 11.0mm)	8.8mm × 6.6mm (φ 11.0mm)
Magnification	1.0x	1.5x	2.0x
Working Distance	111.5mm	110.7mm	110.9mm
Resolving Power *1	6.9μm	5.2μm	4.5μm
Depth of Field *2	0.82mm	0.42mm	0.27mm
NA	0.049	0.064	0.075
Effective F-number	10.1	11.5	13.0
TV Distortion	-0.003%	0.031%	-0.019%

Mount	C-Mount	C-Mount	C-Mount
Weight (with coaxial type)	108g	110g	115g
Weight (straight type)	105g	108g	113g

WD-110mm

TEC-M30110MPC / TEC-M30110MP

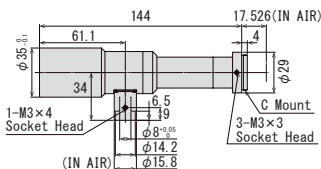

TEC-M30110MPC

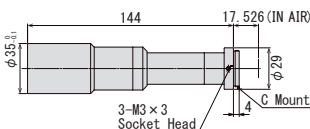

TEC-M30110MP

TEC-M40110MPC / TEC-M40110MP

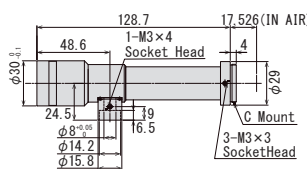

TEC-M40110MPC

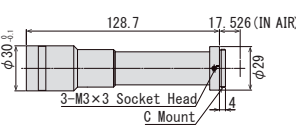

TEC-M40110MP

TEC-M60110MPC / TEC-M60110MP

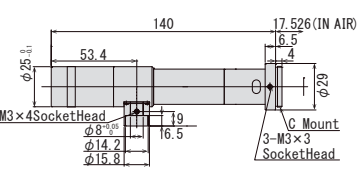

TEC-M60110MPC

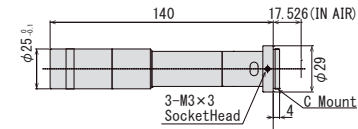

TEC-M60110MP

Model (with coaxial type)	TEC-M30110MPC	TEC-M40110MPC	TEC-M60110MPC
Model (straight type)	TEC-M30110MP	TEC-M40110MP	TEC-M60110MP
Format	2/3" φ12.8mm	8.8mm × 6.6mm (φ 11.0mm)	2/3" φ12.8mm
Magnification	3.0x	4.0x	6.0x
Working Distance	111.4mm	110.5mm	110mm
Resolving Power *1	3.6μm	3.7μm	4.4μm
Depth of Field *2	0.14mm	0.11mm	0.09mm
NA	0.094	0.091	0.076
Effective F-number	16.0	21.9	39.6
TV Distortion	-0.012%	-0.004%	-0.015%

Mount	C-Mount	C-Mount	C-Mount
Weight (with coaxial type)	166g	121g	103g
Weight (straight type)	160g	120g	101g

*1 : Theoretical resolution calculated with a wavelength of 550nm *2 : Value calculated with a permissible circle of confusion of 40μm



MPYIR Series

1.1" IR CORRECTIVE 12 MEGAPIXEL LENS for ITS

Model No.	Format	Focal Length	F No.	IRIS	Working Distance	Weight
V2518FIC-MPYIR	1.1"	25mm	F1.8 - F16C	Manual	1m - Inf.	158g
V3518FIC-MPYIR		35mm			2m - Inf.	153g
V5020FIC-MPYIR		50mm			3m - Inf.	151g
VG2518KC-MPYIR		25mm	F1.8 - F16C	P-IRIS	1m - Inf.	127g
VG3518KC-MPYIR		35mm			2m - Inf.	123g
VG5020KC-MPYIR		50mm			3m - Inf.	121g

V2518FIC-MPYIR

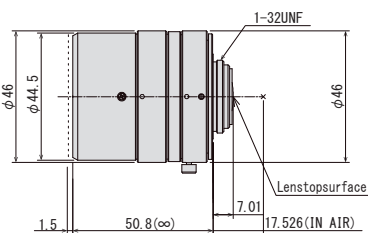

V3518FIC-MPYIR

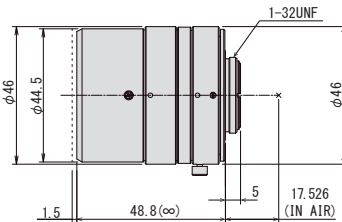

V5020FIC-MPYIR

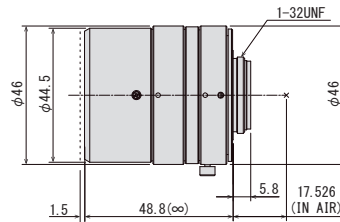

Focal Length	25mm	35mm	50mm
Max. Aperture Ratio	1:1.8	1:1.8	1:2.0
Max. Image Format	14.2mm × 10.4mm (φ 17.6mm)	14.2mm × 10.4mm (φ 17.6mm)	14.2mm × 10.4mm (φ 17.6mm)
Operation Range	Iris F1.8 - F16C	F1.8 - F16C	F2.0 - F16C
	Focus 1m - Inf.	2m - Inf.	3m - Inf.
Control	Iris Manual	Manual	Manual
	Focus Manual	Manual	Manual
Angle of View	D 38.8°	27.4°	19.4°
	H 31.8°	22.3°	15.7°
	V 23.6°	16.5°	11.6°
Operating Temperature	-10°C - +50°C		-10°C - +50°C

Back Focal Length	10.6mm	14.2mm	14.2mm
Flange Back Length	17.526mm	17.526mm	17.526mm
Mount	C-Mount	C-Mount	C-Mount
Filter Size	M40.5 P=0.5mm	M40.5 P=0.5mm	M40.5 P=0.5mm
Dimensions	φ46mm × 50.8mm	φ46mm × 48.8mm	φ46mm × 48.8mm
Weight	158g	153g	151g

- Suitable for 1.1" 12MP sensor, same size as conventional products
- Usable lineup for ANPR, 25mm/35mm/50mm
- Manual iris and P-iris options are available for each focal length
- No focus shift from visible light to NIR
- High spectral transmittance between visible light to NIR

1.1"

12MP

MANUAL

FIX

IR

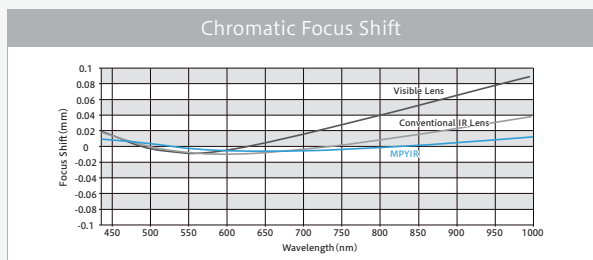

VG2518KC-MPYIR

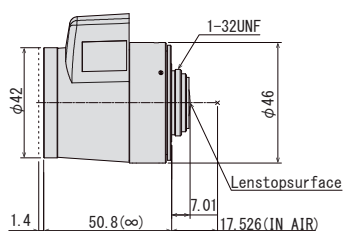

VG3518KC-MPYIR

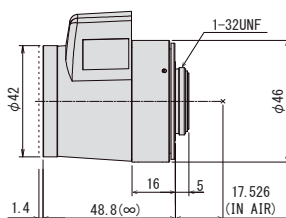

VG5020KC-MPYIR

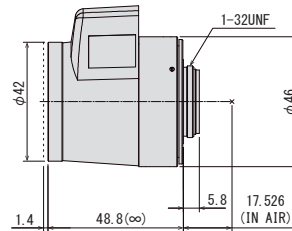

Focal Length	25mm				35mm				50mm			
Max. Aperture Ratio	1:1.8				1:1.8				1:2.0			
Max. Image Format	14.2mm × 10.4mm (φ 17.6mm)				14.2mm × 10.4mm (φ 17.6mm)				14.2mm × 10.4mm (φ 17.6mm)			
Operation Range	Iris	F1.8 - F16C			F1.8 - F16C				F2.0 - F16C			
	Focus	1m - Inf.			2m - Inf.				3m - Inf.			
Control	Iris	Stepping Motor			Stepping Motor				Stepping Motor			
	Focus	Manual			Manual				Manual			
Angle of View	D	38.8°	35.6°	24.9°	27.4°	25.1°	17.4°	19.4°	17.7°	12.2°		
	H	1.1" 31.8°	1" 28.8°	2/3" 20.0°	1.1" 22.3°	1" 20.2°	2/3" 14.0°	1.1" 15.7°	1" 14.2°	2/3" 9.8°		
	V	23.6°	21.8°	15.1°	16.5°	15.2°	10.5°	11.6°	10.7°	7.4°		
Operating Temperature	-10°C - +50°C				-10°C - +50°C				-10°C - +50°C			

Back Focal Length	10.6mm	14.2mm	14.2mm
Flange Back Length	17.526mm	17.526mm	17.526mm
Mount	C-Mount	C-Mount	C-Mount
Filter Size	M40.5 P=0.5mm	M40.5 P=0.5mm	M40.5 P=0.5mm
Dimensions	φ42mm × 57mm × 50.8mm	φ42mm × 57mm × 48.8mm	φ42mm × 57mm × 48.8mm
Weight	127g	123g	121g

MPIR Series

2/3" IR CORRECTIVE 5 MEGAPIXEL LENS for ITS



Model No.	Format	Focal Length	F No.	IRIS	Working Distance	Weight
M2514FIC-MPIR	2/3"	25mm	F1.4 - F16C	Manual	1m - Inf.	154g
M3518FIC-MPIR		35mm	F1.8 - F16C		1m - Inf.	149g
M5020FIC-MPIR		50mm	F2.0 - F16C		2m - Inf.	155g
MG2514KC-MPIR		25mm	F1.4 - F16C	P-IRIS	1m - Inf.	128g
MG3518KC-MPIR		35mm	F1.8 - F16C		1m - Inf.	123g
MG5020KC-MPIR		50mm	F2.0 - F16C		2m - Inf.	129g

M2514FIC-MPIR

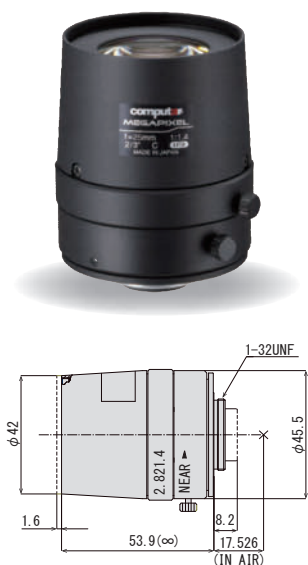

M3518FIC-MPIR

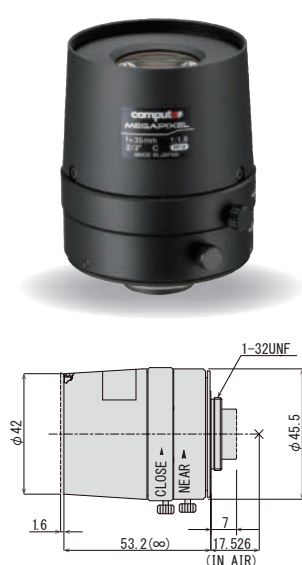

M5020FIC-MPIR

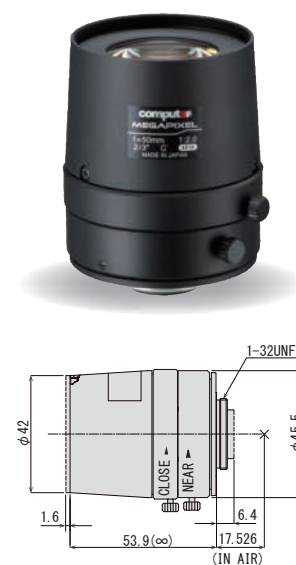

Focal Length	25mm	35mm	50mm	
Max. Aperture Ratio	1:1.4	1:1.8	1:2.0	
Max. Image Format	11.3mm × 6.0mm (φ 12.8mm)			
Operation Range	Iris	F1.4 - F16C	F1.8 - F16C	
	Focus	1m - Inf.	1m - Inf.	
Control	Iris	Manual	Manual	
	Focus	Manual	Manual	
Angle of View	D	24.9°	18.2°	13.7°
	H	2/3" 20.0°	1/2" 14.6°	1/3" 11.0°
	V	15.1°	11.0°	8.2°
CMV2000 11.264 × 5.984 (φ 12.75)	D	28.6°		
	H	25.4°		
	V	13.7°		
Operating Temperature	-10°C - +50°C			

Back Focal Length	10.8mm	14.3mm	14.8mm
Flange Back Length	17.526mm	17.526mm	17.526mm
Mount	C-Mount	C-Mount	C-Mount
Filter Size	M40.5 P=0.5mm	M40.5 P=0.5mm	M40.5 P=0.5mm
Dimensions	φ46.5mm × 53.9mm	φ46.5mm × 53.2mm	φ46.5mm × 53.9mm
Weight	154g	149g	155g

- Suitable for 2/3" 5MP sensors
- Compact design
- Usable lineup for ANPR, 25mm, 35mm, and 50mm
- Manual iris and P-iris options are available for each focal length
- Minimizes focus shift between visible light to NIR
- High spectral transmittance between visible light to NIR



MG2514KC-MPIR

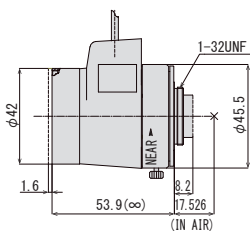

MG3518KC-MPIR

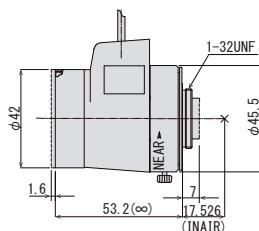

MG5020KC-MPIR

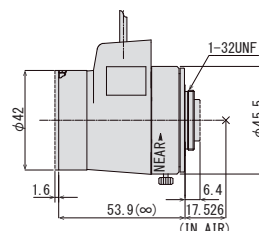

Focal Length	25mm				35mm				50mm			
Max. Aperture Ratio	1:1.4				1:1.8				1:2.0			
Max. Image Format	11.3mm × 6.0mm (φ 12.8mm)				11.3mm × 6.0mm (φ 12.8mm)				11.3mm × 6.0mm (φ 12.8mm)			
Operation Range	Iris	F1.4 - F16C			F1.8 - F16C			F2.0 - F16C				
	Focus	1m - Inf.			1m - Inf.			2m - Inf.				
Control	Iris	Stepping Motor			Stepping Motor			Stepping Motor				
	Focus	Manual			Manual			Manual				
Angle of View	D	24.9°	18.2°	13.7°	17.4°	12.7°	9.5°	12.2°	8.9°	6.7°		
	H	2/3" 20.0°	1/2" 14.6°	1/3" 11.0°	2/3" 13.9°	1/2" 10.2°	1/3" 7.6°	2/3" 9.8°	1/2" 7.1°	1/3" 5.3°		
	V	15.1°	11.0°	8.2°	10.5°	7.6°	5.7°	7.3°	5.3°	4.0°		
CMV2000 11.264 × 5.984 (φ 12.75)	D	28.6°			20.0°			14.1°				
	H	25.4°			17.8°			12.5°				
	V	13.7°			9.5°			6.7°				
Operating Temperature	-10°C - +50°C				-10°C - +50°C				-10°C - +50°C			

Back Focal Length	10.8mm	14.3mm	14.8mm
Flange Back Length	17.526mm	17.526mm	17.526mm
Mount	C-Mount	C-Mount	C-Mount
Filter Size	M40.5 P=0.5mm	M40.5 P=0.5mm	M40.5 P=0.5mm
Dimensions	φ 42mm × 58.6mm × 53.9mm	φ 42mm × 56.8mm × 53.2 mm	φ 42mm × 56.8mm × 53.9mm
Weight	128g	123g	129g

NEW

8MEGAPIXEL LOW DISTORTION BOARD LENS

1/1.8" 8MP FIX BOARD



3 MEGAPIXEL ULTRA-LOW DISTORTION BOARD LENS

1/1.8" 3MP FIX BOARD



1 MEGAPIXEL BOARD LENS

1/2" 1MP FIX BOARD



Model Name	E0828KY	E1228KY	E1628KY	E1220KV	E1620KV	E2520KV	H0320KP	H0624KP	H0924KP	H1620KP	H2520KP	
Format	1/1.8"	1/1.8"	1/1.8"	1/1.8"	1/1.8"	1/1.8"	1/2"	1/2"	1/2"	1/2"	1/2"	
Mount	M12											
Pitch	0.5											
Focal Length	8mm	12mm	16mm	12.0mm	16.0mm	25.0mm	3mm	6mm	9mm	16mm	25mm	
Aperture	F2.8	F2.8	F2.8	F2.0	F2.0	F2.0	F2.0	F2.4	F2.4	F2.0	F2.0	
Optical Distortion	-0.20%	-0.20%	0.29%	0.04%	-0.07%	0.02%	-37.5%	-9.0%	-1.6%	0.4%	1.0%	
Angle of View at Inf.	D	56.1°	39.1°	30.6°	39.5°	30.0°	19.5°	125.3°	72.5°	48.6°	27.9°	18.0°
	H	1/1.8" 44.7°	1/1.8" 30.5°	1/1.8" 23.7°	1/1.8" 32.1°	1/1.8" 24.3°	1/1.8" 15.7°	1/2" 104.3°	1/2" 59.1°	1/2" 39.6°	1/2" 22.6°	1/2" 14.5°
	V	38.0°	25.7°	20.0°	24.4°	18.4°	11.9°	80.5°	45.0°	30.1°	17.0°	10.9°
	D	54.7°	38°	29.7°	36.8°	27.9°	18.1°	98.6°	55.6°	37.3°	21.2°	13.6°
	H	1/2" 43.5°	1/2" 29.7°	1/2" 23.1°	1/2" 29.8°	1/2" 22.6°	1/2" 14.6°	1/3" 80.5°	1/3" 45.0°	1/3" 30.1°	1/3" 17.0°	1/3" 10.9°
	V	36.7°	24.8°	19.3°	22.6°	17.0°	11.0°	61.3°	34.0°	22.7°	12.8°	8.2°
	D	40.3°	27.3°	21.3°	28.1°	21.2°	13.7°	75.8°	42.3°	28.3°	16.0°	10.3°
	H	1/3" 32.7°	1/3" 22.1°	1/3" 17.1°	1/3" 22.6°	1/3" 17.0°	1/3" 11.0°	1/4" 61.3°	1/4" 34.0°	1/4" 22.7°	1/4" 12.8°	1/4" 8.2°
	V	24.8°	16.6°	12.9°	17.1°	12.8°	8.2°	46.3°	25.6°	17.1°	9.6°	6.2°

NEW

12MEGAPIXEL FISHEYE BOARD LENS

1/1.6" 12MP IR
FIX FISHEYE



4K FISHEYE BOARD LENS

1/1.7" 1/1.8" 4K IR FIX FISHEYE



5 MEGAPIXEL FISHEYE BOARD LENS

1/2.5" 5MP IR
FIX FISHEYE



Model Name	E1722KRY	E1222KRY	E1628KRY	E1222KF3RY	E1628KF3RY	E2328KRY	L1028KRW	L1028KDRW	
Format	1/1.6"	1/1.7"	1/1.7"	1/1.7"	1/1.7"	1/1.8"	1/2.5"	1/2.5"	
Mount	M12								
Pitch	0.5								
Focal Length	1.7mm	1.2mm	1.6mm	1.2mm	1.6mm	2.3mm	1.05mm	1.05mm	
Aperture	F2.2	F2.2	F2.8	F2.2	F2.8	F2.8	F2.8	F2.8	
Angle of View at Inf.	D	185.0°							
	H	1/1.6" 185.0°	1/1.7" 185.0°	1/1.7" 190.0°	1/1.7" 185.0°	1/1.7" 190.0°	1/1.8" 190.0°	1/2.5" 180.0°	1/2.5" 180.0°
	V	185.0°					108.6°		
	D	185.0°	185.0°	190.0°	185.0°	190.0°			
	H	1/1.8" 185.0°	1/3" 171.5°	1/3" 168.2°	1/3" 171.5°	1/3" 168.2°	1/2" 159.0°	1/3" 180.0°	1/3" 180.0°
	V	149.1°	139.5°	125.5°	139.5°	125.5°	119.5°	163.2°	163.2°
	D		164.2°	157.3°	164.2°	157.3°	149.2°	180.0°	180.0°
	H		1/4" 139.5°	1/4" 125.5°	1/4" 139.5°	1/4" 125.5°	1/3" 119.5°	1/4" 163.2°	1/4" 163.2°
	V		110.3°	94.2°	110.3°	94.2°	89.6°	130.2°	130.2°
	IRCF				○	○			○

EX1.5C



EX2C



VM100



VM400



Description	1.5X Extender for C-mount	2X Extender for C-mount	Extension Tube Kit 40, 20, 10, 5, 1, 0.5mm	5mm Adapter Ring
Application	Attached between lens and camera - Makes focal length 1.5X	Attached between lens and camera - Makes focal length 2X	Attached between lens and camera - Reduces minimum focusing distance	Attached between lens and camera - Adapts C-mount lens to CS-mount camera

M55-0.75X



M55-2.0X



VM0811



VM0810



Description	Rear converter 0.75X (Designed for TEC-M55)	Rear converter 2.0X (Designed for TEC-M55)	Filter holder for V0828-MPY2 (M72 P=0.75)	Filter holder for V0828-MPY2 (M67 P=0.75)
Application	Makes focal length 0.75X	Makes focal length 2.0X	Attached between filter and lens for 1.1" sensor camera	Attached between filter and lens for 1" sensor camera

ZM0810



VM0918



TM1243



TM1643



Description	Filter holder for V0826-MPZ (M82 P=0.75)	Filter holder for EG6Z0915 series (M67 P=0.75)	Filter holder for F1228-MPT (M72 P=0.75)	Filter holder for F1628-MPT (M52 P=0.75)
Application	Attached between filter and lens for 1" sensor camera	Attached between filter and lens	Attached between filter and lens for 1.4" sensor camera	Attached between filter and lens for 1.4" sensor camera

XM0823



Description	Filter holder for M0828-MPX (M82 P=0.75)
Application	Attached between filter and lens for 2/3" sensor camera

NEW

Ruggedized Series



- Designed for harsh environments with vibration resistance (10G) and shock resistance (15G)
- Customizable to your desired F-number
- High-resolution lens over 20MP (custom-made to order)
- Floating structure ensures high performance from close-up to long-distance
- Close-focus design with a minimum distance of 0.1 m
- Compact and lightweight design
- Available for small-quantity orders

※ [IEC 60068-2-6 compliant]

· Frequency 10-60Hz (amplitude 0.75mm), Frequency 60-500Hz (acceleration 100m/S²)

Model Name	Format	Focal Length	F No.	Working Distance	Distortion	Weight
V0826-MPZ-R	1"	8mm	F2.6	0.1m - Inf	-0.8%(y=8.0)	196g
V1226-MPZ-R	1"	12mm	F2.6	0.1m - Inf	0.0%(y=8.0)	98.4g
V1624-MPZ-R	1"	16mm	F2.4	0.1m - Inf	0.0%(y=8.0)	108.1g
V2520-MPZ-R	1"	25mm	F2.0	0.15m - Inf	0.0%(y=8.0)	73.1g
V3522-MPZ-R	1"	35mm	F2.2	0.2m - Inf	0.0%(y=8.0)	118.2g
V5024-MPZ-R	1"	50mm	F2.4	0.2m - Inf	0.0%(y=8.0)	138.5g
V7531-MPZ-R	1"	75mm	F3.1	0.25m - Inf	0.0%(y=8.0)	176.1g
V0828-MPY-R	1.1"	8mm	F2.8	0.2m - Inf	-0.6%(y=8.8)	157.4g
F1628-MPT-R	1.4"	16mm	F2.8	0.15m - Inf	0.06%(y=11.55)	187g
F3526-MPT-R	1.4"	35mm	F2.6	0.15m - Inf	0.01%(y=11.55)	122g

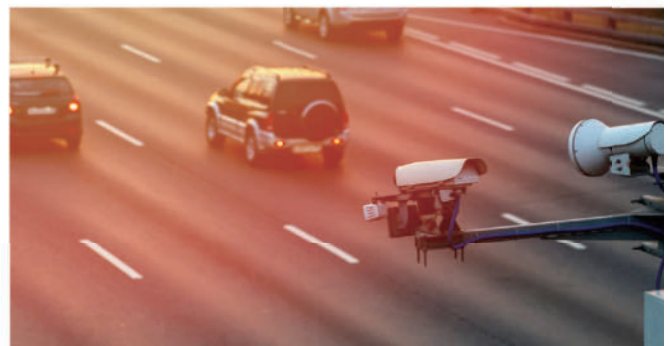
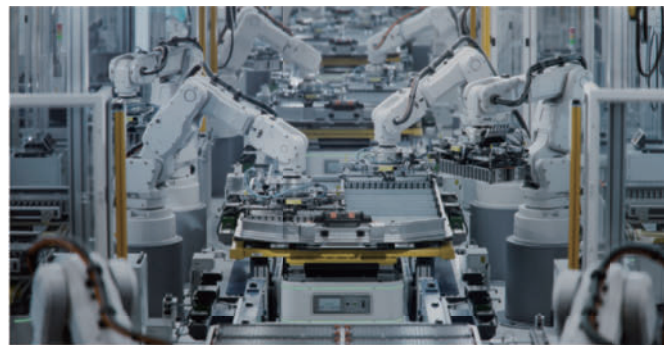



4K/5MP Varifocal Lens

- Ultra-high-resolution 5MP and 8MP (4K) models
- High performance from center to the edge, ideal for multi-ROI
- Day/Night design, minimizing focus shift at NIR
- Various focal lengths from wide 2.8mm to telephoto 50mm
- F1.5 flat F-stop from wide to telephoto (EG6Z0915)
- 100mm Super telephoto model (EG7Z1519)

Model Name	Format	Mount	Focal Length	F No.	Type	M.O.D	Front Filter Thread	Dimensions (mm)			Weight
								φ	H	D	
E3Z3915CS-MPWIR	1/1.8"	CS	3.9mm - 10mm	F1.5 - F16C	Manual	0.8m	-	43	-	59	69g
EG3Z3915FCS-MPWIR	1/1.8"	CS	3.9mm - 10mm	F1.5 - F360C	DC	0.8m	-	40	49	59	72g
EG3Z3915KCS-MPWIR	1/1.8"	CS	3.9mm - 10mm	F1.5 - F16C	P-iris	0.8m	-	40	49	59	71g
EG3Z3915TCS-MPWIR	1/1.8"	CS	3.9mm - 10mm	F1.5 - F16C	i-CS	0.8m	-	54	67	59	109g
EG6Z0915FCS-MPWIR	1/1.8"	CS	9mm - 50mm	F1.5 - F360C	DC	3.0m	M67 P=0.75mm	68	83	104	279g
EG6Z0915KCS-MPWIR	1/1.8"	CS	9mm - 50mm	F1.5 - F16C	P-iris	3.0m	M67 P=0.75mm	68	83	104	278g
EG6Z0915TCS-MPWIR	1/1.8"	CS	9mm - 50mm	F1.5 - F16C	i-CS	3.0m	M67 P=0.75mm	77	84	104	291g
NEW EG7Z1519KCS-MPWIR	1/1.8"	CS	15mm - 100mm	F1.9 - F16C	P-iris	3.0m	M52 P=0.75mm	54	49	123	433g
A3Z2812CS-MPWIR	1/2.7"	CS	2.8mm - 8.5mm	F1.2 - F16C	Manual	0.5m	-	43	-	59	64g
AG3Z2812FCS-MPWIR	1/2.7"	CS	2.8mm - 8.5mm	F1.2 - F360C	DC	0.5m	-	40	49	59	67g
AG3Z2812KCS-MPWIR	1/2.7"	CS	2.8mm - 8.5mm	F1.2 - F16C	P-iris	0.5m	-	40	49	59	66g
AG3Z2812TCS-MPWIR	1/2.7"	CS	2.8mm - 8.5mm	F1.2 - F16C	i-CS	0.5m	-	55	68	59	103g



3MP Varifocal Lens

- 1/2.7" 3MP
- Compact design
- Various focal lengths, from wide to telephoto
- Each model available in manual iris, DC iris, and P-iris

Model Name	Format	Mount	Focal Length	F No.	Type	M.O.D	Front Filter Thread	Dimensions (mm)			Weight
								φ	H	D	
A4Z2812CS-MPIR	1/2.7"	CS	2.8mm - 10mm	F1.2 - F16C	Manual	0.5m	-	43.6	-	59	63g
AG4Z2812FCS-MPIR	1/2.7"	CS	2.8mm - 10mm	F1.2 - F360C	DC	0.5m	-	40	49	59	66g
AG4Z2812KCS-MPIR	1/2.7"	CS	2.8mm - 10mm	F1.2 - F16C	P-iris	0.5m	-	40	49	59	65g
A6Z8516CS-MP	1/2.7"	CS	8.5mm - 50mm	F1.6 - F16C	Manual	1.0m	M40.5 P=0.5mm	49	-	58	77g
AG6Z8516FCS-MP	1/2.7"	CS	8.5mm - 50mm	F1.6 - F360C	DC	1.0m	M40.5 P=0.5mm	46	60	58	80g
AG6Z8516KCS-MP	1/2.7"	CS	8.5mm - 50mm	F1.6 - F16C	P-iris	1.0m	M40.5 P=0.5mm	46	60	58	78g
A4Z1214CS-MPIR	1/2.7"	CS	12.5mm - 50mm	F1.4 - F16C	Manual	1.0m	M40.5 P=0.5mm	49	-	58	80g
AG4Z1214FCS-MPIR	1/2.7"	CS	12.5mm - 50mm	F1.4 - F360C	DC	1.0m	M40.5 P=0.5mm	46	59.3	58	83g
AG4Z1214KCS-MPIR	1/2.7"	CS	12.5mm - 50mm	F1.4 - F16C	P-iris	1.0m	M40.5 P=0.5mm	40	49	59	81g



Direct Mount Varifocal Lens

- Resolution up to 8MP supported
- Various image format options available from 1/3" to 1/1.2"
- Compatible with the latest IMX485/585 models (NSF2.3Z5915BHRW)

1. Calculation of Working Distance (WD)

Distance from lens to object (WD) is calculated by putting the size of a camera's imaging device, focal length, and an object size into the following formula.

<Formula>
 $WD = H1 + y \times f / y'$

[Ex]
 When 2/3" camera with M2514-MP2 films an object whose vertical size is 120 mm.
 f : 25 mm
 H1 : 23.8mm
 y : 120mm
 y' : 6.6mm

Distance from lens to object=
 $WD = 23.8 + 120 \times 25 / 6.6 = 478.35\text{mm}$

2. Calculation of Focal Length

When choosing size of a camera's imaging device, the object size and WD are fixed, focal length can be calculated by the following formula. You can select appropriate lens from the focal length.

<Formula>
 $f = y' \times WD / y$

f : focal length of lens
 WD : distance from lens to object
 H1 : first principal point
 y : vertical size of object
 y' : vertical size of camera's imaging device

CAMERA FORMAT

The size of the camera's imaging device also affects the angle of view, with the smaller devices creating narrower angles of view when used on the same lens. The format of the lens, however, is irrelevant to the angle of view; it merely needs to project an image that will cover the device, e.g., the same format as the camera or larger. This also means that 1/3" cameras can utilize the entire range of lenses from 1/3" to 2/3", with a 1/3" 8mm lens giving the same angle as a 2/3" 8mm lens. The latter combination also provides increased resolution and picture quality as only the center of the lens is being utilized, where the optics can be ground more accurately.

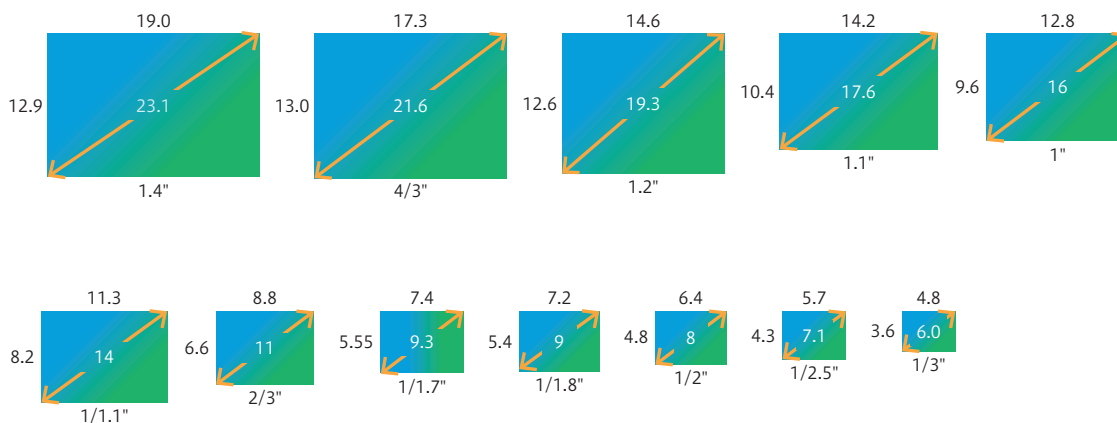
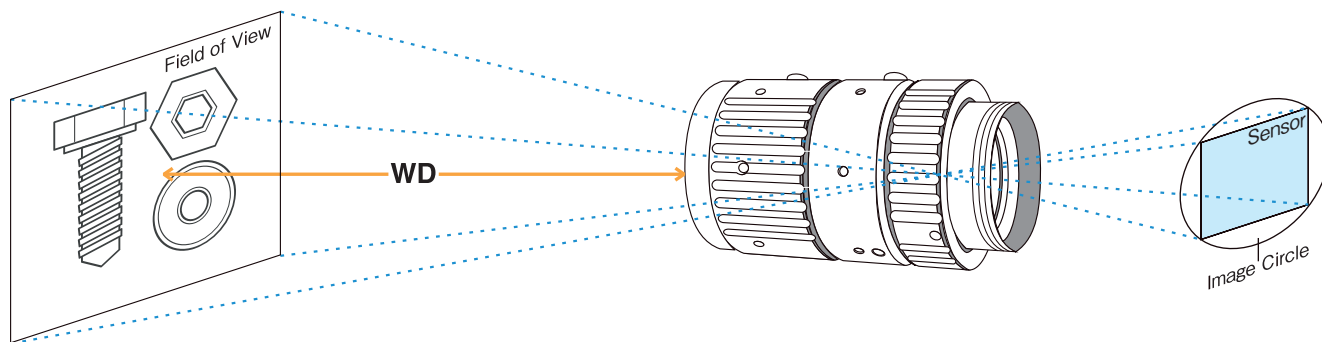

* This specification is subject to change without any notice.

C or CS MOUNT

Modern cameras and lenses are generally CS mount. With CS mount cameras, both types of lenses can be used, but the C mount lens requires a 5mm ring (VM400) to be fitted between the camera and lens to achieve a focused image. With C mount cameras, it is impossible to use CS mount lenses as it is not physically possible to get the lens close enough to the sensor to achieve a focused image.

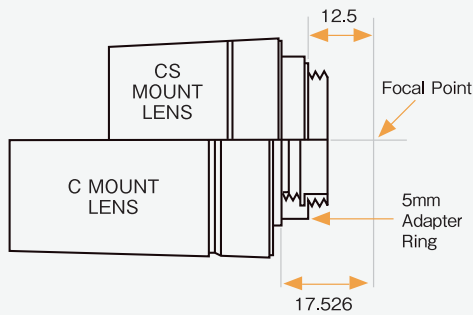

	C mount lens	CS mount lens
C mount camera	○	×
CS mount camera	needs 5mm ring	○

FLANGE BACK, BACK FOCAL LENGTH, AND MECHANICAL BACK FOCAL LENGTH

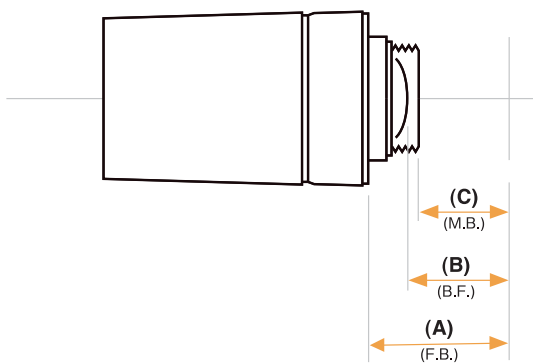

(A) Flange Back
Distance between the lens flange and focal plane

(B) Back Focal Length
Distance between the surface of the rear lens element and focal plane

(C) Mechanical Back Focal Length
Distance between the surface of the lens frame and focal plane

MECHANISM AND ADVANTAGEOUS EFFECT OF IR LENS

■ VISIBLE LENS

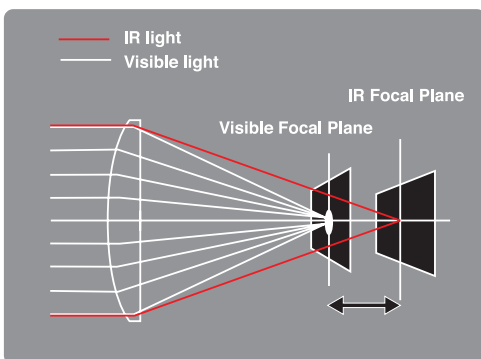

■ IR LENS

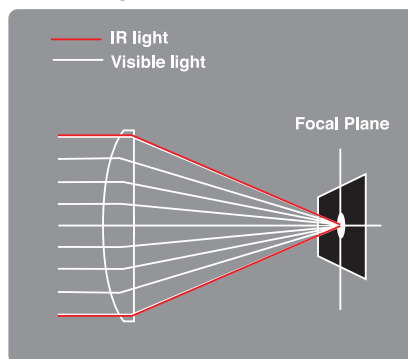

■ Hyper-APO LENS

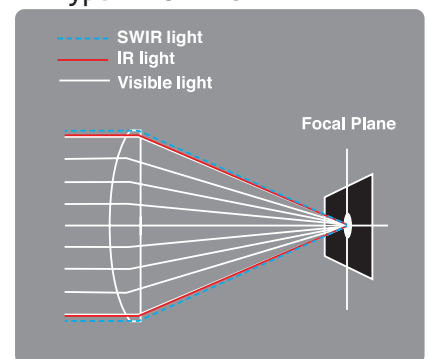

Day/Night cameras typically operate in the near-infrared/infrared zones at night, making the image "out of focus" and unsuitable if used with a conventional lens. Computar has developed IR Lenses that utilize a unique optical glass material that minimizes light dispersion. As a result, refocusing is not required when used with infrared lighting. The lens is manufactured with a special ED glass (extra dispersion) which does not widely disperse light of different wavelengths and has a "special coating." This combination allows the lens to deliver perfect focus under normal and IR illumination by transmitting more light to the infrared region.

computar®



2-15-13, Tsukishima, Chuo-ku,
Tokyo 104-0052, Japan
TEL: +81(0)3 3536 4766 FAX : +81(0)3 3536 4172
www.cbc.co.jp

www.computar-global.com/jp/
www.computar-global.com



CBC AMERICA LLC, Computar Optics
NC +1 919 230-8700 . CA +1 310 222-8600 . NY 212 655-0309

www.computar.com

